

DIGITAL HD VIDEO CAMERA

GR-HD1

Please visit our Homepage on the World Wide Web for Digital Video Camera:

<http://www.jvc-victor.co.jp/english/cyber/>

For Accessories:

<http://www.jvc-victor.co.jp/english/accessory/>

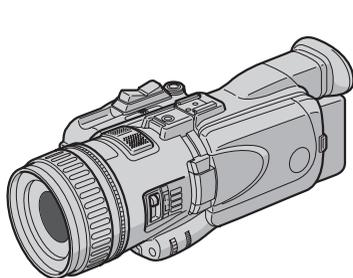

Mini DV NTSC
DSC
DIGITAL
STILL CAMERA

INSTRUCTIONS

For Customer Use:

Enter below the Model No. and Serial No. which is located on the bottom of the camcorder. Retain this information for future reference.

Model No. _____

Serial No. _____

<i>GETTING STARTED</i>	<i>12</i>
<i>VIDEO RECORDING & PLAYBACK</i>	<i>20</i>
<i>DIGITAL STILL CAMERA (D.S.C.) RECORDING & PLAYBACK</i>	<i>28</i>
<i>ADVANCED FEATURES</i>	<i>35</i>
<i>REFERENCES</i>	<i>69</i>
<i>TERMS</i>	<i>88</i>

Dear Customer,

Thank you for purchasing this digital video camera. Before use, please read the safety information and precautions contained in the following pages to ensure safe use of this product.

Using This Instruction Manual

- All major sections are listed in the Table Of Contents on the cover page.
- Notes appear after most subsections. Be sure to read these as well.
- Basic and advanced features/operation are separated for easier reference.

It is recommended that you...

- ... refer to the Index (☞ pg. 84 – 87) and familiarize yourself with button locations, etc. before use.
- ... read thoroughly the Safety Precautions and Safety Instructions that follow. They contain extremely important information regarding the safe use of this product.

You are recommended to carefully read the cautions on pages 78 through 80 before use.

SAFETY PRECAUTIONS

	CAUTION RISK OF ELECTRIC SHOCK DO NOT OPEN	
<p>CAUTION: TO REDUCE THE RISK OF ELECTRIC SHOCK, DO NOT REMOVE COVER (OR BACK). NO USER-SERVICEABLE PARTS INSIDE. REFER SERVICING TO QUALIFIED SERVICE PERSONNEL.</p>		



The lightning flash with arrowhead symbol, within an equilateral triangle, is intended to alert the user to the presence of uninsulated "dangerous voltage" within the product's enclosure that may be of sufficient magnitude to constitute a risk of electric shock to persons.



The exclamation point within an equilateral triangle is intended to alert the user to the presence of important operating and maintenance (servicing) instructions in the literature accompanying the appliance.

The AA-V40U AC Power Adapter/Charger should be used with:

AC 120 V~, 60 Hz in the USA and Canada, AC 110 V - 240 V~, 50 Hz/60 Hz in other countries.

CAUTION (applies to the AA-V40U)

TO PREVENT ELECTRIC SHOCK MATCH WIDE BLADE OF PLUG TO WIDE SLOT, FULLY INSERT.

ATTENTION (s'applique à l'AA-V40U)

POUR ÉVITER LES CHOCS ÉLECTRIQUES, INTRODUIRE LA LAME LA PLUS LARGE DE LA FICHE DANS LA BORNE CORRESPONDANTE DE LA PRISE ET POUSSER JUSQU'AU FOND.

WARNING:

TO PREVENT FIRE OR SHOCK HAZARD, DO NOT EXPOSE THIS UNIT TO RAIN OR MOISTURE.

NOTES:

- The rating plate (serial number plate) and safety caution are on the bottom and/or the back of the main unit.
- The rating plate (serial number plate) of the AC Power Adapter/Charger is on its bottom.

CAUTIONS:

- This camcorder is designed to be used with NTSC-type color television signals. It cannot be used for playback with a television of a different standard. However, live recording and LCD monitor/viewfinder playback are possible anywhere.
- Use the JVC BN-V416U/V428U battery packs and, to recharge them or supply power to the camcorder from an AC outlet, use the provided multi-voltage AC Power Adapter/Charger. (An appropriate conversion adapter may be necessary to accommodate different designs of AC outlets in different countries.)

When the equipment is installed in a cabinet or on a shelf, make sure that it has sufficient space on all sides to allow for ventilation (10 cm (3-15/16") or more on both sides, on top and at the rear).

Do not block the ventilation holes.

(If the ventilation holes are blocked by a newspaper, or cloth etc. the heat may not be able to get out.)

No naked flame sources, such as lighted candles, should be placed on the apparatus.

When discarding batteries, environmental problems must be considered and the local rules or laws governing the disposal of these batteries must be followed strictly.

The apparatus shall not be exposed to dripping or splashing.

Do not use this equipment in a bathroom or places with water.

Also do not place any containers filled with water or liquids (such as cosmetics or medicines, flower vases, potted plants, cups etc.) on top of this unit.

(If water or liquid is allowed to enter this equipment, fire or electric shock may be caused.)

This product has a fluorescent lamp that contains a small amount of mercury. Disposal of these materials may be regulated in your community due to environmental considerations.

For disposal or recycling information please contact your local authorities, or the Electronics Industries Alliance:

<<http://www.eiae.org>>

IMPORTANT PRODUCT SAFETY INSTRUCTIONS

Electrical energy can perform many useful functions. But improper use can result in potential electrical shock or fire hazards. This product has been engineered and manufactured to assure your personal safety. In order not to defeat the built-in safeguards, observe the following basic rules for its installation, use and servicing.

ATTENTION:

Follow and obey all warnings and instructions marked on your product and its operating instructions. For your safety, please read all the safety and operating instructions before you operate this product and keep this manual for future reference.

INSTALLATION

1. Grounding or Polarization

(A) Your product may be equipped with a polarized alternating-current line plug (a plug having one blade wider than the other). This plug will fit into the power outlet only one way. This is a safety feature.

If you are unable to insert the plug fully into the outlet, try reversing the plug. If the plug should still fail to fit, contact your electrician to replace your obsolete outlet. Do not defeat the safety purpose of the polarized plug.

(B) Your product may be equipped with a 3-wire grounding-type plug, a plug having a third (grounding) pin. This plug will only fit into a grounding-type power outlet. This is a safety feature.

If you are unable to insert the plug into the outlet, contact your electrician to replace your obsolete outlet. Do not defeat the safety purpose of the grounding-type plug.

2. Power Sources

Operate your product only from the type of power source indicated on the marking label. If you are not sure of the type of power supply to your home, consult your product dealer or local power company. If your product is intended to operate from battery power, or other sources, refer to the operating instructions.

3. Overloading

Do not overload wall outlets, extension cords, or integral convenience receptacles as this can result in a risk of fire or electric shock.

4. Power Cord Protection

Power supply cords should be routed so that they are not likely to be walked on or pinched by items placed upon or against them, paying particular attention to cords at plugs, convenience receptacles, and the point where they exit from the product.

5. Ventilation

Slots and openings in the cabinet are provided for ventilation. To ensure reliable operation of the product and to protect it from overheating, these openings must not be blocked or covered.

- Do not block the openings by placing the product on a bed, sofa, rug or other similar surface.
- Do not place the product in a built-in installation such as a bookcase or rack unless proper ventilation is provided or the manufacturer's instructions have been adhered to.

6. Wall or Ceiling Mounting

The product should be mounted to a wall or ceiling only as recommended by the manufacturer.

ANTENNA INSTALLATION INSTRUCTIONS

1. Outdoor Antenna Grounding

If an outside antenna or cable system is connected to the product, be sure the antenna or cable system is grounded so as to provide some protection against voltage surges and built-up static charges. Article 810 of the National Electrical Code, ANSI/NFPA 70, provides information with regard to proper grounding of the mast and supporting structure, grounding of the lead-in wire to an antenna discharge unit, size of grounding conductors, location of antenna discharge unit, connection to grounding electrodes, and requirements for the grounding electrode.

2. Lightning

For added protection for this product during a lightning storm, or when it is left unattended and unused for long periods of time, unplug it from the wall outlet and disconnect the antenna or cable system. This will prevent damage to the product due to lightning and power-line surges.

3. Power Lines

An outside antenna system should not be located in the vicinity of overhead power lines or other electric light or power circuits, or where it can fall into such power lines or circuits. When installing an outside antenna system, extreme care should be taken to keep from touching such power lines or circuits as contact with them might be fatal.

EXAMPLE OF ANTENNA GROUNDING AS PER NATIONAL ELECTRICAL CODE, ANSI/NFPA 70

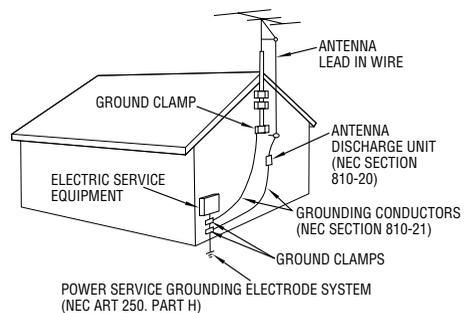

NEC - NATIONAL ELECTRICAL CODE

USE

1. Accessories

To avoid personal injury:

- Do not place this product on an unstable cart, stand, tripod, bracket or table. It may fall, causing serious injury to a child or adult, and serious damage to the product.
- Use only with a cart, stand, tripod, bracket, or table recommended by the manufacturer or sold with the product.
- Use a mounting accessory recommended by the manufacturer and follow the manufacturer's instructions for any mounting of the product.
- Do not try to roll a cart with small casters across thresholds or deep-pile carpets.

2. Product and Cart Combination

A product and cart combination should be moved with care. Quick stops, excessive force, and uneven surfaces may cause the product and cart combination to overturn.

PORTABLE CART WARNING
(Symbol provided by RETAC)



3. Water and Moisture

Do not use this product near water-for example, near a bath tub, wash bowl, kitchen sink or laundry tub, in a wet basement, or near a swimming pool and the like.

4. Object and Liquid Entry

Never push objects of any kind into this product through openings as they may touch dangerous voltage points or short-out parts that could result in a fire or electric shock. Never spill liquid of any kind on the product.

5. Attachments

Do not use attachments not recommended by the manufacturer of this product as they may cause hazards.

6. Cleaning

Unplug this product from the wall outlet before cleaning. Do not use liquid cleaners or aerosol cleaners. Use a damp cloth for cleaning.

7. Heat

The product should be situated away from heat sources such as radiators, heat registers, stoves, or other products (including amplifiers) that produce heat.

SERVICING

1. Servicing

If your product is not operating correctly or exhibits a marked change in performance and you are unable to restore normal operation by following the detailed procedure in its operating instructions, do not attempt to service it yourself as opening or removing covers may expose you to dangerous voltage or other hazards. Refer all servicing to qualified service personnel.

2. Damage Requiring Service

Unplug this product from the wall outlet and refer servicing to qualified service personnel under the following conditions:

- When the power supply cord or plug is damaged.
- If liquid has been spilled, or objects have fallen into the product.
- If the product has been exposed to rain or water.
- If the product does not operate normally by following the operating instructions. Adjust only those controls that are covered by the operating instructions as an improper adjustment of other controls may result in damage and will often require extensive work by a qualified technician to restore the product to its normal operation.
- If the product has been dropped or damaged in any way.
- When the product exhibits a distinct change in performance-this indicates a need for service.

3. Replacement Parts

When replacement parts are required, be sure the service technician has used replacement parts specified by the manufacturer or have the same characteristics as the original part. Unauthorized substitutions may result in fire, electric shock or other hazards.

4. Safety Check

Upon completion of any service or repairs to this product, ask the service technician to perform safety checks to determine that the product is in safe operating condition.

SAFETY PRECAUTIONS

Do not point the lens or the viewfinder directly into the sun. This can cause eye injuries, as well as lead to the malfunctioning of internal circuitry. There is also a risk of fire or electric shock.

CAUTION!

The following notes concern possible physical damage to the camcorder and to the user.

When carrying, be sure to always securely attach and use the provided strap. Carrying or holding the camcorder by the viewfinder and/or the LCD monitor can result in dropping the unit, or in a malfunction.

Take care not to get your finger caught in the cassette holder cover. Do not let children operate the camcorder, as they are particularly susceptible to this type of injury.

Do not use a tripod on unsteady or unlevel surfaces. It could tip over, causing serious damage to the camcorder.

CAUTION!

Connecting cables (S/AV/Editing, USB, etc.) to the camcorder and leaving it on top of the TV is not recommended, as tripping on the cables will cause the camcorder to fall, resulting in damage.



- This camcorder is designed exclusively for the digital video cassette, SD Memory Card and MultiMediaCard. Only cassettes marked "Mini DV" and memory cards marked "SD" or "MultiMediaCard" can be used with this unit.

Before recording an important scene...

- ... make sure you only use cassettes with the Mini DV mark .
- ... make sure you only use memory cards with the mark  or *MultiMediaCard*.
- ... remember that this camcorder is not compatible with other digital video formats.
- ... remember that this camcorder is intended for private consumer use only. Any commercial use without proper permission is prohibited. (Even if you record an event such as a show, performance or exhibition for personal enjoyment, it is strongly recommended that you obtain permission beforehand.)

Provided Accessories



AC Power Adapter/
Charger AA-V40U



DC Cord

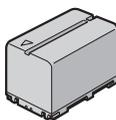

Battery Pack
BN-V428U

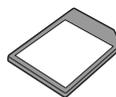

Memory Card 8 MB
(Already inserted in the
camcorder)

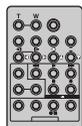

Remote Control Unit
RM-V717U

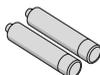

AAA (R03) Battery x 2
(for remote control unit)

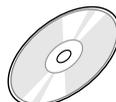

CD-ROM

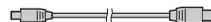

USB Cable



Lens Hood
(Already attached to the
camcorder; see pg. 8)

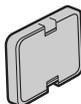

Lens Cap
(see pg. 8 for attachment)

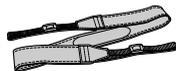

Shoulder Strap
(see pg. 10 for attachment)

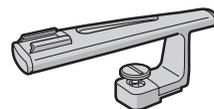

Handle
(see pg. 10 for attachment)



S/AV/Editing Cable

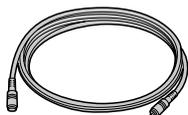

Editing Extension Cable



Component Video Cable

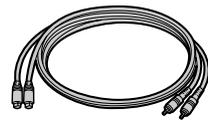

Audio Extension Cable



Audio Cable x 2
(for connection of
optional headphones
and external microphone
see pg. 10)

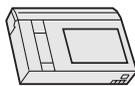

Cleaning Cassette



Core Filter
(see pg. 9 for attachment)

- Large x 1
- Medium x 3
- Small x 3

NOTES:

- In order to maintain optimum performance of the camcorder, provided cables may be equipped with one or more core filter. If a cable has only one core filter, the end that is closest to the filter should be connected to the camcorder.
- Make sure to use the provided cables for connections. Do not use any other cables.

How To Detach/Attach The Lens Hood

The provided lens hood helps block out glare when shooting under bright sunlight, the same way professional photographers do.

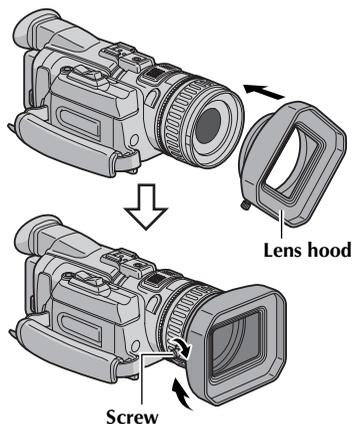

To detach

- 1 Loosen the screw on the lens hood.
- 2 Turn the lens hood counterclockwise.

To attach

- 1 While slanting the lens hood, align the lens hood with the camcorder's lens, and then turn it clockwise.
- 2 Tighten the screw on the lens hood.

NOTE:

Normally, use the camcorder with the lens hood attached. Remove the lens hood only when you use the optional wide or telephoto conversion lens.

How To Attach The Lens Cap

To protect the lens, attach the provided lens cap to the lens hood when camcorder is not in use.

NOTE:

You cannot attach the lens cap directly to the camcorder.

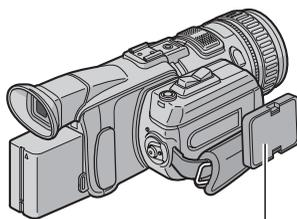
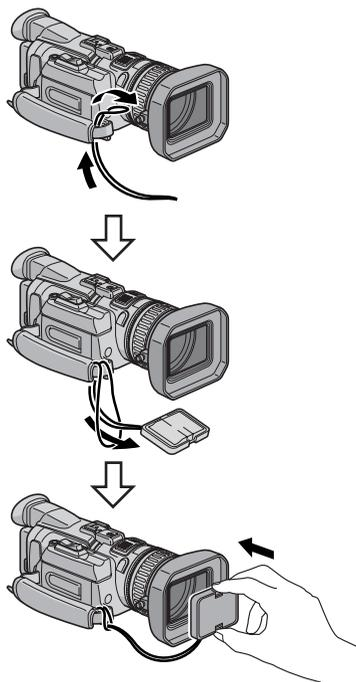

Place here during shooting.

How To Attach The Core Filter

Attach the core filters to the cables. The core filter reduces interference.

Types of core filters

Size	Cable	Times to wind
Large	i.LINK cable*	Twice
Medium	USB cable**	Once
	Component video cable***	—
Small	DC cord Audio cable	Once

* Optional
(If you have an optional JVC i.LINK cable VC-VDV206U or VC-VDV204U with core filters, it is not necessary to attach the provided core filter. If you are going to use any other i.LINK cable, attach the provided core filter.)

** Attach two core filters to both ends of the cable.

*** Not necessary to wind the cable.

The procedure below is an example of winding cable once.

- 1 Release the stoppers on both ends of the core filter.



- 2 Run the cable through the core filter, leaving approx. 3 cm of cable between the cable plug and the core filter. Wind the cable once around the outside of the core filter as shown in the illustration.

- Wind the cable so that it is not slack.

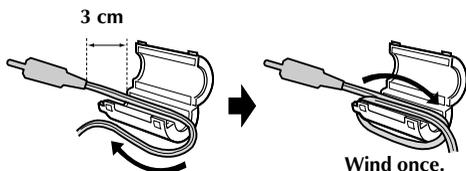

- 3 Close the core filter until it clicks shut.

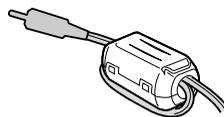

To attach the core filter to the component video cable

- 1) Release the stoppers on both ends of the core filter.
- 2) Run the cable through the core filter, leaving approx. 3 cm of cable between the cable plug and the core filter.

3 cm

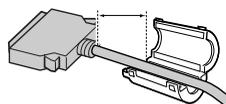

- 3) Close the core filter until it clicks shut.

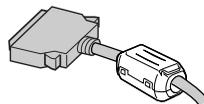

NOTES:

- Take care not to damage the cable.
- When connecting a cable, attach the end with the core filter to the camcorder.

How To Attach The Strap

- 1 Following the illustration, thread the strap through the eyelet ①.
- 2 Fold it back and thread it through the buckle ②.
- 3 Repeat the procedure to attach the other end of the strap to the other eyelet ③.
- 4 Confirm the strap is not twisted.

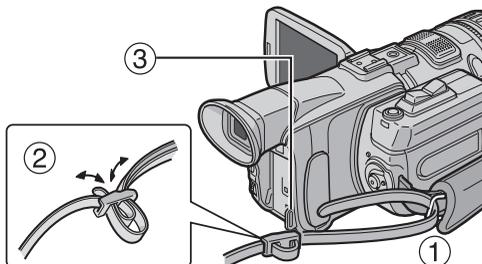

How To Attach The Handle

Mount the Handle on the Shoe and tighten the screw. You can attach the optional Video Light or Stereo Microphone to the Shoe on the Handle or on the camcorder's Shoe. When using the Microphone or Video Light, refer also to its instruction manual.

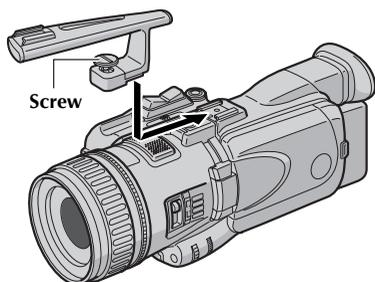

How To Use The Audio Cable

When using optional headphones or external microphone, connect to the provided audio cable (with a core filter attached), then connect the audio cable to the camcorder. The core filter reduces interference.

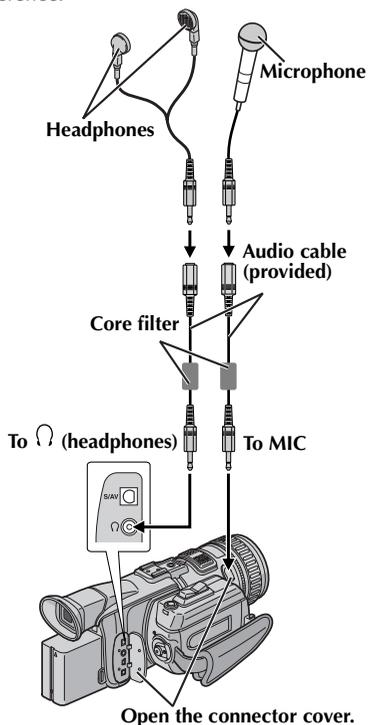

GETTING STARTED	12	ADVANCED FEATURES	35
Power	12	MENUS FOR DETAILED ADJUSTMENT	35
Grip Adjustment	14	Changing The Menu Settings	35
Tripod Mounting	14	RECORDING MENUS	36
LCD Monitor And Viewfinder	14	PLAYBACK MENUS	41
Viewfinder Adjustment	15	FEATURES FOR RECORDING	43
Brightness Adjustment Of The Display	15	Self-Timer	43
Operation Mode	16	Snapshot (For Video Recording)	44
Date/Time Settings	17	Exposure Control	44
Loading A Cassette		Iris Lock	45
/Unloading A Cassette	18	Backlight Compensation	45
Loading A Memory Card		Manual Shutter Speed Adjustment	46
/Unloading A Memory Card	19	Manual Iris Adjustment	46
VIDEO RECORDING & PLAYBACK	20	Auto Focus	46
VIDEO RECORDING	20	Manual Focus	47
Basic Recording	20	Manual Zooming	47
Recording Mode	21	White Balance Adjustment	48
Tape Remaining Time	22	Manual White Balance Adjustment	49
Zooming	22	Wipe Or Fader Effects	50
Journalistic Shooting	22	Program AE	50
Interface Shooting	22	Special Effects	51
Time Code	23	NAVIGATION Function	52
Recording From The Middle Of A Tape	23	DUBBING	54
VIDEO PLAYBACK	24	Dubbing To Or From A VCR	54
Normal Playback	24	Dubbing To Or From A Video Unit Equipped With	
Still Playback	24	An i.LINK Connector (Digital Dubbing)	55
Frame-By-Frame Playback	24	Dubbing Still Images Recorded On A Tape To	
Shuttle Search	25	A Memory Card	57
Blank Search	25	USING THE REMOTE CONTROL UNIT	58
Connections To A TV Or VCR	26	Audio Dubbing (DV only)	60
DIGITAL STILL CAMERA (D.S.C.) RECORDING &		Insert Editing (DV only)	61
PLAYBACK	28	Random Assemble Editing [R.A.Edit] (DV only)	62
D.S.C. RECORDING	28	SYSTEM CONNECTIONS	67
Basic Shooting (D.S.C. Snapshot)	28	Connection To A Personal Computer	67
D.S.C. PLAYBACK	29	Using The Camcorder As A WebCam	68
Normal Playback Of Images	29	REFERENCES	69
Auto Playback Of Images	29	DETAILS	69
Index Playback Of Files	30	TROUBLESHOOTING	70
Viewing File Information	30	CAUTIONS	78
Removing On-Screen Display	30	USER MAINTENANCE	81
Protecting Files	31	SPECIFICATIONS	82
Deleting Files	32	INDEX	84
Resetting The File Name	33	TERMS	88
Setting Print Information (DPOF Setting)	33		
Initializing A Memory Card	34		

Power

This camcorder's 2-way power supply system lets you choose the most appropriate source of power. Do not use provided power supply units with other equipment.

Charging The Battery Pack

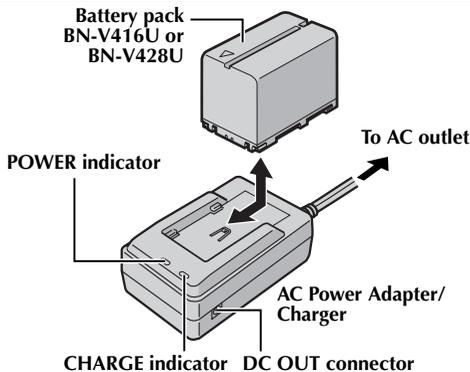

- 1 Make sure you unplug the camcorder's DC cord from the AC Power Adapter/Charger.
- 2 Plug the AC Power Adapter/Charger's power cord into an AC outlet. The POWER indicator lights.
- 3 Attach the battery pack with the ⊕⊖ mark aligned with the corresponding marks on the AC Power Adapter/Charger. The CHARGE indicator begins blinking to indicate charging has started.
- 4 When the CHARGE indicator stops blinking but stays lit, charging is finished. Remove the battery pack.
- 5 Unplug the AC Power Adapter/Charger's power cord from the AC outlet.

Battery pack	Charging time
BN-V416U	Approx. 2 hr.
BN-V428U*	Approx. 3 hr. 20 min.

* Provided

NOTES:

- If the protective cap is attached to the battery pack, remove it first.
- If you connect the camcorder's DC cord to the AC Power Adapter/Charger during battery charging, power is supplied to the camcorder and charging stops.
- Charging is not possible if the wrong type of battery is used.
- When charging the battery pack for the first time or after a long storage period, the CHARGE indicator may not light. In this case, remove the

battery pack from the AC Power Adapter/Charger, then try charging again.

- If the battery operation time remains extremely short even after having been fully charged, the battery is worn out and needs to be replaced. Please purchase a new one.
- For other notes, see pg. 69.

Using The Battery Pack

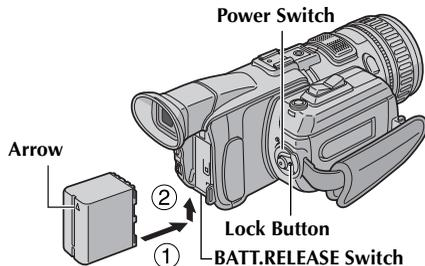

- 1 With the arrow on the battery pack pointing upward, push the battery pack slightly against the battery pack mount ①.
- 2 Slide up the battery pack until it locks in place ②.

To detach the battery pack...

Slide the battery pack down slightly while sliding BATT. RELEASE to detach it.

NOTES:

- Recording time is reduced significantly under the following conditions:
 - Zoom or Record-Standby mode is engaged repeatedly.
 - The LCD monitor is used repeatedly.
 - The playback mode is engaged repeatedly.
- Before extended use, it is recommended that you prepare enough battery packs to cover 3 times the planned shooting time.

ATTENTION:

Before detaching the power source, make sure that the camcorder's power is turned off. Failure to do so can result in a camcorder malfunction.

INFORMATION:

The optional extended-use battery pack kit is a set composed of a battery pack and AC Power Adapter/Charger:

VU-V840 KIT: BN-V840U battery pack & AA-V15U AC Power Adapter/Charger

VU-V856 KIT: BN-V856U battery pack & AA-V80U AC Power Adapter/Charger

Read the kit's instruction manual before using.

Also, by using the optional JVC VC-VBN856U DC Cord, it will be possible to connect BN-V840U or BN-V856U battery packs to the camcorder and supply power directly to the camcorder.

Using AC Power

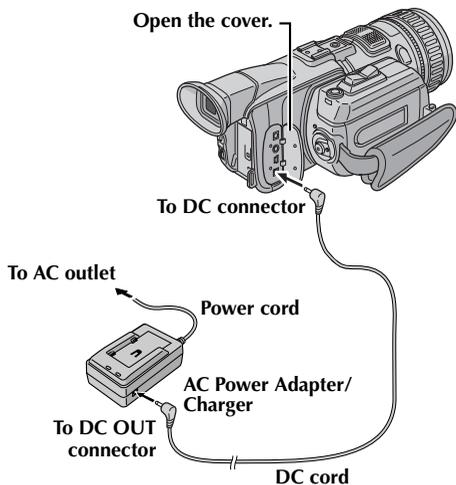

- 1** Make sure you unplug the camcorder's DC cord from the AC Power Adapter/Charger.
- 2** Plug the AC Power Adapter/Charger's power cord into an AC outlet. The POWER indicator lights.
- 3** Plug the DC cord jack with smaller diameter to the camcorder's DC connector.
- 4** Plug the DC cord jack with larger diameter to the DC OUT connector on the AC Power Adapter/Charger.

NOTES:

- The provided AC Power Adapter/Charger features automatic voltage selection in the AC range from 110 V to 240 V.
- For other notes, see pg. 69.

About Batteries

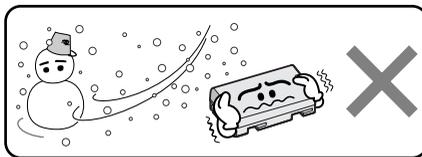

Lithium-ion is vulnerable in colder temperatures.



DANGER! Do not attempt to take the batteries apart, or expose them to flame or excessive heat, as it may cause a fire or explosion.

WARNING! Do not allow the battery or its terminals to come in contact with metals, as this can result in a short circuit and possibly start a fire.

The Benefits Of Lithium-Ion Batteries

Lithium-ion battery packs are small but have a large power capacity. However, when one is exposed to cold temperatures (below 10°C/50°F), its usage time becomes shorter and it may cease to function. If this happens, place the battery pack in your pocket or other warm, protected place for a short time, then re-attach it to the camcorder. As long as the battery pack itself is not cold, it should not affect performance.

(If you're using a heating pad, make sure the battery pack does not come in direct contact with it.)

For other notes, see pg. 69.

Grip Adjustment

- 1 Adjust the velcro strip.
- 2 Pass your right hand through the loop and grasp the grip.
- 3 Adjust your thumb and fingers through the grip to easily operate the Recording Start/Stop Button, Power Switch, SNAPSHOT and Power Zoom Switch. Be sure to fasten the velcro strip to your preference.

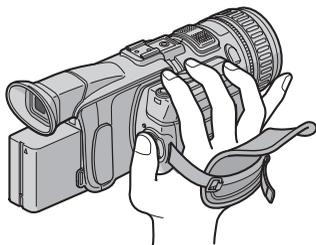

NOTE:

The grip can rotate 90° downward. It is useful to shoot images below.

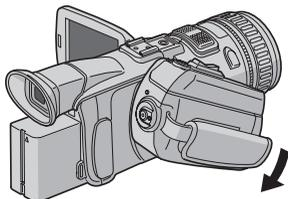

Tripod Mounting

To attach the camcorder to a tripod, align the direction stud and screw to the mounting socket and stud hole on the camcorder. Then tighten the screw clockwise.

- Some tripods are not equipped with studs.

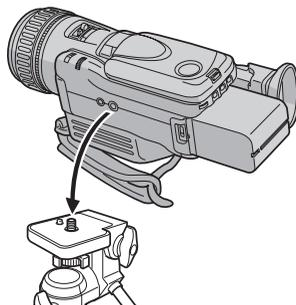

CAUTION:

When attaching the camcorder to a tripod, extend its legs to stabilize the camcorder. It is not advised to use small sized tripods. This may cause damage to the unit by falling over.

LCD Monitor And Viewfinder

While using the LCD monitor:

Make sure the viewfinder is pushed back in. Press **PUSH OPEN** and open the LCD monitor fully. It can rotate 270° (90° downward, 180° upward).

While using the viewfinder:

Make sure the LCD monitor is closed and locked. Pull out the viewfinder fully.

- Be sure to pull out the viewfinder until you hear a click, otherwise it may be pushed back in during use.

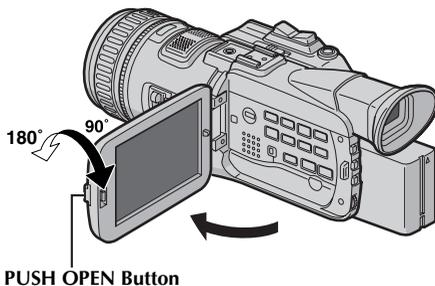

NOTES:

- When the viewfinder is pulled out while the LCD monitor is opened, you can select whether you use the LCD monitor and the viewfinder simultaneously or individually. Set "PRIORITY" to the desired mode in SYSTEM Menu. (☞ pg. 35, 38)
- The image on the LCD monitor (or viewfinder) and the image on the TV screen may look differently in terms of the brightness and color. Confirm the final image on the TV screen.
- Colored bright spots may appear all over the LCD monitor or the viewfinder. However, this is not a malfunction. (☞ pg. 74)

Viewfinder Adjustment

- 1 Set the Power Switch to "A" or "M" while pressing down the Lock Button located on the switch.
- 2 Make sure the LCD monitor is closed and locked. Pull out the viewfinder fully and adjust it manually for best viewability.
- 3 Turn the Diopter Adjustment Control until the indications in the viewfinder are clearly focused.

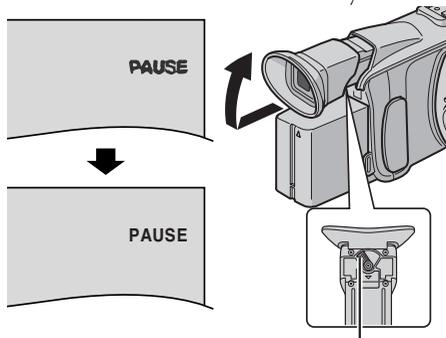

Diopter Adjustment Control

CAUTION:

When retracting the viewfinder, take care not to pinch your fingers.

Brightness Adjustment Of The Display

- 1 Set the Power Switch to "M" or "PLAY" while pressing down the Lock Button located on the switch.
- 2 Open the LCD monitor fully, or pull out the viewfinder fully.
- 3 Press the MENU Wheel in. The Menu Screen appears.
- 4 Rotate the MENU Wheel to select "☐", and press it. The CAMERA DISPLAY Menu appears.
- 5 Rotate the MENU Wheel to select "BRIGHT", and press it. The Menu Screen closes and the brightness control indicator appears.
- 6 Rotate the MENU Wheel until the appropriate brightness is reached.
- 7 Press the MENU Wheel in.
 - It is also possible to adjust the brightness of the viewfinder.

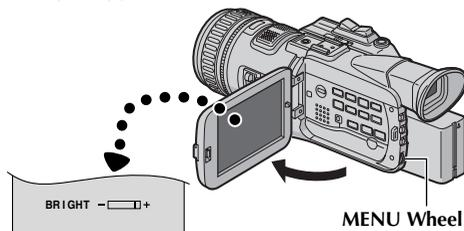

Operation Mode

To turn on the camcorder, turn the Power Switch to align any operation mode except "OFF" to the Power Lamp while pressing down the Lock Button located on the switch.

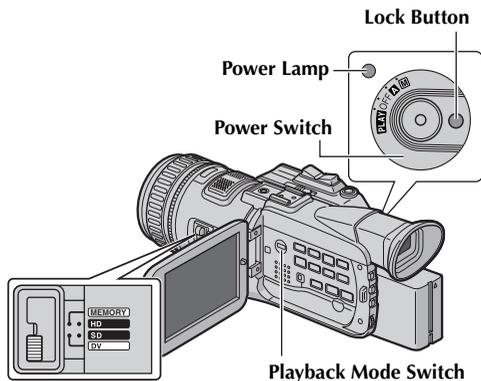

Recording Mode Switch

Choose the appropriate operation mode according to your preference using Power Switch and Recording Mode Switch for recording or Playback Mode Switch for playback.

Recording Mode Switch Position
MEMORY: Allows you to record still images on a memory card.
HD/SD/DV: Allows you to record on a tape in MPEG2 (480p/720p) format or DV format (480i). For details, refer to "Recording Mode" (☞ pg. 21).

Playback Mode Switch Position
VIDEO: Allows you to play back a tape.
MEMORY: Allows you to play back images stored in a memory card or access data stored in a memory card.

Power-Linked Operation

When the Power Switch is set to "A" or "M", you can also turn on/off the camcorder by opening/closing the LCD monitor or pulling out/pushing in the viewfinder.

Power Switch Position
A (Full Auto Recording): Allows you to record using NO special effects or manual adjustments. Suitable for standard recording. The "A" indicator appears on the display.
M (Manual Recording): Allows you to set various recording functions using the Menus. (☞ pg. 35) If you want more creative capabilities than Full Auto Recording, try this mode. There is no indication on the display.
OFF: Allows you to switch off the camcorder.
PLAY: <ul style="list-style-type: none"> ● Allows you to play back a recording on the tape. ● Allows you to display a still image stored in the memory card or to transfer a still image stored in the memory card to a PC. ● Allows you to set various playback functions using the Menus. (☞ pg. 35)

Date/Time Settings

The date/time is recorded onto the tape at all times, but its display can be turned on or off during playback. (▶ pg. 35, 42)

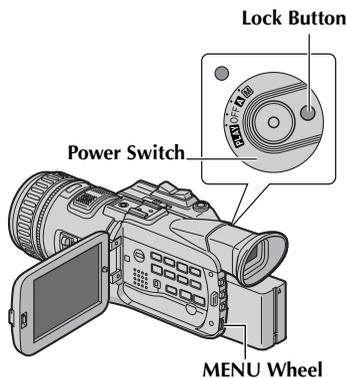

1 Set the Power Switch to “M” while pressing down the Lock Button located on the switch.

2 Open the LCD monitor fully, or pull out the viewfinder fully.

3 Press the **MENU** Wheel in. The Menu Screen appears.

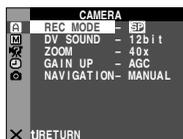

4 Rotate the **MENU** Wheel to select “CAMERA DISPLAY”, and press it. The CAMERA DISPLAY Menu appears.



5 Rotate the **MENU** Wheel to select “CLOCK ADJ.”, and press it. The parameter for “Month” is highlighted.

6 Rotate the **MENU** Wheel to input the month, and press it. Repeat to input the day, year, hour and minute.



7 Rotate the **MENU** Wheel to select “RETURN”, and press it twice. The Menu Screen closes.

Built-in Clock's Rechargeable Lithium Battery

To store the date/time in memory, the clock's rechargeable lithium battery is integrated in the camcorder. While the camcorder is connected to an AC outlet using the AC Power Adapter/Charger, or while the battery pack attached to the camcorder continues to supply power, the clock's rechargeable lithium battery is always charged. However, if the camcorder is not used for approx. 3 months, the clock's lithium battery will become discharged and the date/time stored in memory will be lost. When this occurs, first connect the camcorder to an AC outlet using the AC Power Adapter/Charger for over 24 hours to charge the clock's rechargeable lithium battery. Then perform the date/time setting before using the camcorder.

Note that the camcorder can be used without setting the date/time.

NOTE:

Even if you select “CLOCK ADJ.”, if the parameter is not highlighted, the camcorder's internal clock continues to operate. Once you move the highlight bar to the first date/time parameter (month), the clock stops. When you finish setting the minute and press the **MENU** Wheel in, the date and time begin operation from the date and time you have just set.

Loading A Cassette /Unloading A Cassette

The camcorder needs to be powered up to load or eject a cassette.

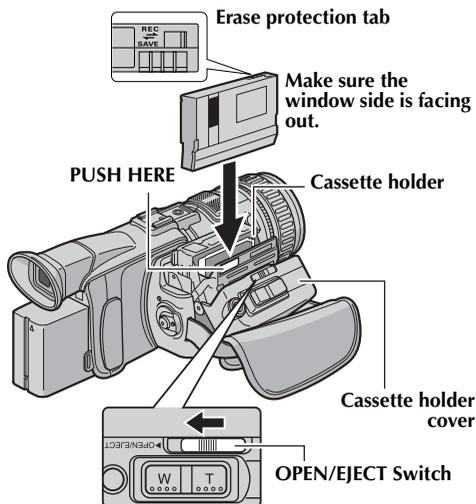

- 1 Loosen the grip strap.
- 2 Slide and hold **OPEN/EJECT** in the direction of the arrow, then pull the cassette holder cover open until it locks. The cassette holder opens automatically.
 - Do not touch internal components.
- 3 Insert or remove a tape and press "PUSH HERE" to close the cassette holder.
 - Be sure to press only the section labeled "PUSH HERE" to close the cassette holder; touching other parts may cause your finger to get caught in the cassette holder, resulting in injury or product damage.
 - Once the cassette holder is closed, it recedes automatically. Wait until it recedes completely before closing the cassette holder cover.
 - When the battery pack's charge is low, you may not be able to close the cassette holder cover. Do not apply force. Replace the battery pack with a fully charged one or use AC power before continuing.
- 4 Close the cassette holder cover firmly until it locks into place.

To protect valuable recordings...

Slide the erase protection tab on the back of the tape in the direction of "SAVE". This prevents the tape from being recorded over. To record on this tape, slide the tab back to "REC" before loading it.

Approximate recording time

Tape	Recording mode	
	SP	LP
30 min.	30 min.	45 min.
60 min.	60 min.	90 min.
80 min.	80 min.	120 min.

To switch the recording mode, refer to pages 35 and 36.

NOTES:

- It takes a few seconds for the cassette holder to open. Do not apply force.
- If you wait a few seconds and the cassette holder does not open, close the cassette holder cover and try again. If the cassette holder still does not open, turn the camcorder off then on again.
- If the tape does not load properly, open the cassette holder cover fully and remove the cassette. A few minutes later, insert it again.
- When the camcorder is suddenly moved from a cold place to a warm environment, wait a short time before opening the cassette holder cover.
- Closing the cassette holder cover before the cassette holder recedes may cause damage to the camcorder.
- Even when the camcorder is switched off, a cassette can be loaded or unloaded. After the cassette holder is closed with the camcorder switched off, however, it may not recede. It is recommended to turn the power on before loading or unloading.
- When resuming recording, once you open the cassette holder cover a blank portion will be recorded on the tape or a previously recorded scene will be erased (recorded over) regardless of whether the cassette holder came out or not. See "Recording From The Middle Of A Tape" (☞ pg. 23).

Loading A Memory Card /Unloading A Memory Card

The provided memory card is already inserted in the camcorder at the time of purchase.

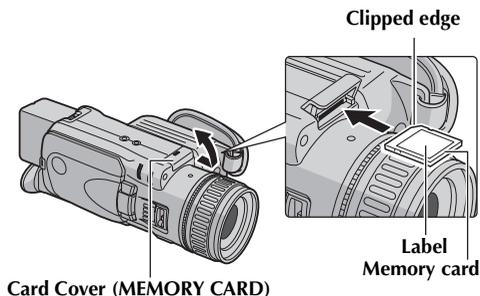

- 1** Make sure the camcorder's power is off.
- 2** Slide to open the card cover (MEMORY CARD).
- 3** **To load a memory card**, firmly insert it with its clipped edge first.
To unload a memory card, push it once. After the memory card comes out of the camcorder, pull it out.
 - Do not touch the terminal on the reverse side of the label.
- 4** Close the card cover.

To protect valuable files (available only for SD Memory Card)...

Write/erase protection tab

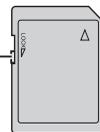

Slide the write/erase protection tab on the side of the memory card in the direction of "LOCK". This prevents the memory card from being recorded over. To record on this memory card, slide the tab back to the position opposite to "LOCK" before loading it.

NOTES:

- Be sure to use only SD Memory Cards marked "SD" or MultiMediaCards marked "MultiMediaCard".
- Some brands of memory cards are not compatible with this camcorder. Before purchasing a memory card, consult its manufacturer or dealer.
- Before using a new memory card, it is necessary to **FORMAT** the card. (☞ pg. 34)

ATTENTION:

Do not insert or remove the memory card while the camcorder is turned on, as this may cause the memory card to be corrupted or cause the camcorder to become unable to recognize whether or not the card is installed.

Basic Recording

NOTE:

Before continuing, perform the procedures listed below:

- Power (☞ pg. 12)
- Loading A Cassette (☞ pg. 18)

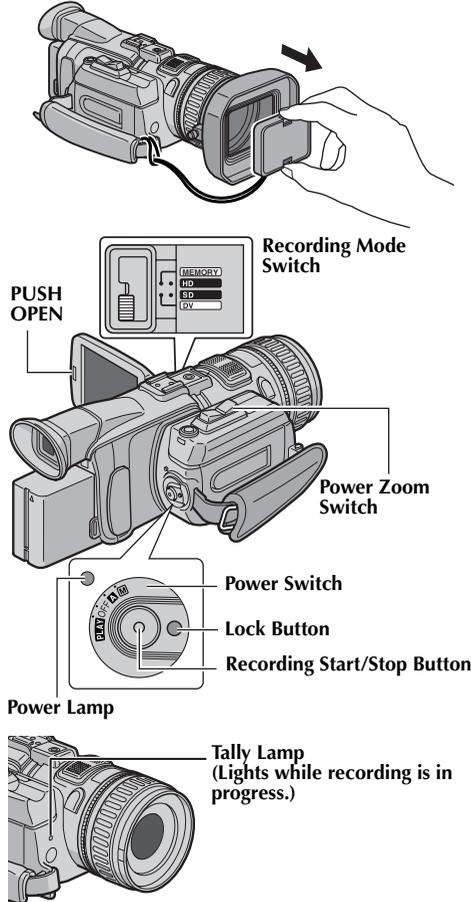

- 1 Remove the lens cap.
- 2 Press **PUSH OPEN** and open the LCD monitor fully, or pull out the viewfinder fully.
- 3 Set the Recording Mode Switch to "HD", "SD" or "DV". For details, refer to "Recording Mode" (☞ pg. 21).
- 4 Set the Power Switch to "A" or "M" while pressing down the Lock Button located on the switch.
 - The power lamp lights and the camcorder enters the Record-Standby mode. "PAUSE" is displayed.
- 5 To start recording, press the Recording Start/Stop Button. The tally lamp lights and "REC" appears on the display while recording is in progress.
- 6 To stop recording, press the Recording Start/Stop Button again. The camcorder re-enters the Record-Standby mode.

NOTES:

- To listen to the sound during recording, connect the optional headphones to the (Headphones) jack.
- If the Record-Standby mode continues for 5 minutes, the camcorder's power shuts off automatically. To turn the camcorder on again, push back and pull out the viewfinder again or close and re-open the LCD monitor.
- LCD monitor/viewfinder indications:
 - When power is supplied from a battery: the " " battery indicator is displayed. (☞ pg. 75)
 - When power is supplied from an AC outlet: the " " battery indicator does not appear.
- When a blank portion is left between recorded scenes on the tape, the time code is interrupted and errors may occur when editing the tape. To avoid this, refer to "Recording From The Middle Of A Tape" (☞ pg. 23).
- To turn the tally lamp or beep sounds off, ☞ pg. 35, 38.
- To record in LP (Long Play) mode, ☞ pg. 35, 36.
- For other notes, ☞ pg. 69.

Recording Mode

Following procedure is an example of the operation; to change the position of the Recording Mode Switch from "DV" to "MEMORY".

- Slide the Recording Mode Switch to right.
 - The switch's position is at "SD".
- Slide the Recording Mode Switch upward.
 - The switch's position is at "HD".
- Slide the Recording Mode Switch to left.
 - The switch's position is at "MEMORY".

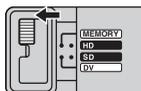
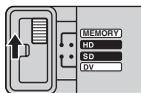
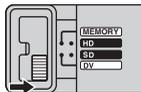

Features for Video Recording Mode

DV:

Allows you to record on a tape in DV format (480i). The camcorder records signals in the interlace scan mode (half of 525 scanning lines at 1/60th of a second).

The image will be recorded in an aspect ratio of 4:3. The DV mode is suitable for playback on a conventional 4:3-screen TV.

SD:

Allows you to record on a tape in MPEG2 format (480p). The camcorder records signals in the progressive scan mode (525 scanning lines at 1/60th a second at one time)

The SD mode reduces flickering more effectively than a recording in DV mode.

The image will be recorded in an aspect ratio of 16:9. The SD mode is suitable for playback on a wide-screen TV or high definition TV.

Supported formats

Horizontal lines	Vertical lines	Aspect ratio	Frames per sec. (REC)	Scan mode	Recording mode
1280	720	16:9	30	Progressive	HD
704	480	16:9	60	Progressive	SD
704	480	4:3	60	Interlaced	DV

Maximum continuous recording time

Battery pack	Viewfinder on		LCD monitor on	
	DV mode	HD/SD mode	DV mode	HD/SD mode
BN-V416U	1 hr. 30 min.	1 hr. 15 min.	1 hr. 10 min.	1 hr.
BN-V428U*	2 hr. 50 min.	2 hr. 15 min.	2 hr. 10 min.	1 hr. 50 min.
BN-V840U	4 hr.	3 hr. 20 min.	3 hr. 10 min.	2 hr. 50 min.
BN-V856U	5 hr. 40 min.	4 hr. 50 min.	4 hr. 30 min.	4 hr.

* Provided

HD:

Allows you to record on a tape in MPEG2 format (720p). The camcorder records signals in the progressive scan mode (750 scanning lines at 1/30th of a second for recording and 1/60th of a second for playback at one time)

The HD mode enables digital high definition recording that offers higher picture quality than a recording in SD or DV mode.

The image will be recorded in an aspect ratio of 16:9. The HD mode is suitable for playback on a wide-screen TV or high definition TV.

Recording modes and features

There are some features which are not available depending on the recording mode.

Yes: Available

No: Not Available

*: Some features are not available.

Features	DV	SD	HD
Frame-By-Frame Playback (☞ pg. 24)	Yes	No	No
5-Second Recording (☞ pg. 37)	Yes	No	No
Wipe Or Fader Effects (☞ pg. 50)	Yes	Yes	*
Special Effects (☞ pg. 51)	Yes	Yes	*
Slow-Motion Playback (☞ pg. 59)	Yes	No	No
Playback Zoom (☞ pg. 59)	Yes	No	No
Playback Special Effects (☞ pg. 60)	Yes	No	No
Audio Dubbing (☞ pg. 60)	Yes	No	No
Insert Editing (☞ pg. 61)	Yes	No	No
Random Assemble Editing [R.A.Edit] (☞ pg. 62)	Yes	No	No

Tape Remaining Time

Approximate tape remaining time appears on the display. “- h -- m” means the camcorder is calculating the remaining time. When the remaining time reaches 2 minutes, the indication starts blinking.

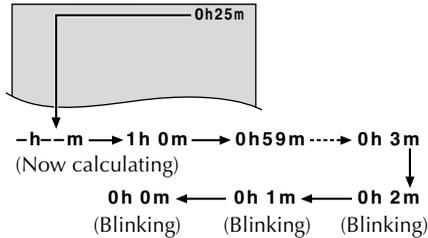

Zooming

Produces the zoom in/out effect, or an instantaneous change in image magnification.

Zoom In

Press the “T” side on the Power Zoom Switch.

Zoom Out

Press the “W” side on the Power Zoom Switch.

- The further you press the Power Zoom Switch, the quicker the zoom action.

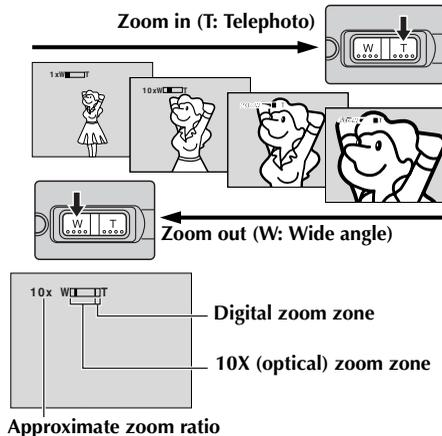

Approximate zoom ratio

NOTES:

- Focusing may become unstable during Zooming. In this case, set the zoom while in Record-Standby, lock the focus by using the manual focus (☞ pg. 47), then zoom in or out in Record mode.
- Zooming is possible to a maximum of 200X, or it can be switched to 10X magnification using the optical zoom. (☞ pg. 36)

- Zoom magnification of over 10X is done through Digital image processing, and is therefore called Digital Zoom.
- During Digital zoom, the quality of image may suffer.
- Digital zoom cannot be used when the Recording Mode Switch is set to “MEMORY” or “HD”.
- Macro shooting (as close as approx. 5 cm (2”) to the subject) is possible when the Power Zoom Lever is set all the way to “W”. Also see “TELE MACRO” in MANUAL Menu on page 37.
- For other notes, ☞ pg. 69.

Journalistic Shooting

In some situations, different shooting angles may provide more dramatic results. Hold the camcorder in the desired position and tilt the LCD monitor and the grip in the most convenient direction. The LCD monitor can rotate 270° (90° downward, 180° upward). The grip can rotate 90° downward.



Interface Shooting

The person you shoot can view himself/herself in the LCD monitor, and you can even shoot yourself while viewing your own image in the LCD monitor.



- 1) Open the LCD monitor and tilt it upward to 180° so that it faces forward.
 - When the LCD monitor is tilted upward to an angle of over approx. 105°, the monitor image is inverted vertically. If the viewfinder is pulled out at that time, it also switches on.
- 2) Point the lens toward the subject (yourself when self-recording) and start recording.
 - During Interface Shooting, the monitor image appears inverted as it would when viewing a mirror. However, the actual recorded image does not appear inverted.

Time Code

During recording, a time code is recorded on the tape. This code is to confirm the location of the recorded scene on the tape during playback.

If recording starts from a blank portion, the time code begins counting from "00:00:00" (minute:second:frame). If recording starts from the end of a previously recorded scene, the time code continues from the last time code number.

To perform Random Assemble Editing (☞ pg. 62 – 66), time code is necessary. If during recording a blank portion is left partway through the tape, the time code is interrupted. When recording is resumed, the time code starts counting up again from "00:00:00". This means the camcorder may record the same time codes as those existing in a previously recorded scene. To prevent this, perform "Recording From The Middle Of A Tape" in the following cases;

- When shooting again after playing back a recorded tape.
- When power shuts off during shooting.
- When a tape is removed and re-inserted during shooting.
- When shooting using a partially recorded tape.
- When shooting on a blank portion located partway through the tape.
- When shooting again after shooting a scene then opening/closing the cassette holder cover.

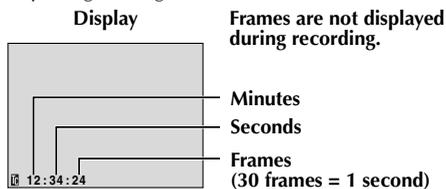

Recording From The Middle Of A Tape

- 1) Play back a tape or use Blank Search (☞ pg. 25) to find the spot at which you want to start recording, then engage the Still Playback mode. (☞ pg. 24)
- 2) Set the Power Switch to "A" or "M" while pressing down the Lock Button located on the switch, then start recording.

NOTES:

- The time code cannot be reset.
- During fast-forwarding and rewinding, the time code indication does not move smoothly.
- The time code is displayed only when "TIME CODE" is set to "ON". (☞ pg. 39)

When a blank portion is recorded on a tape

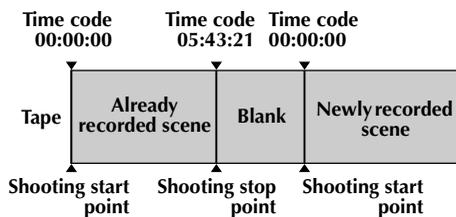

Proper recording

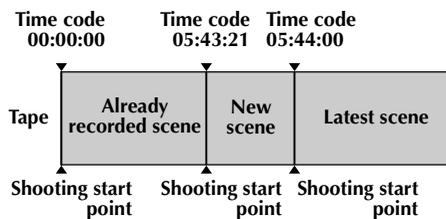

Normal Playback

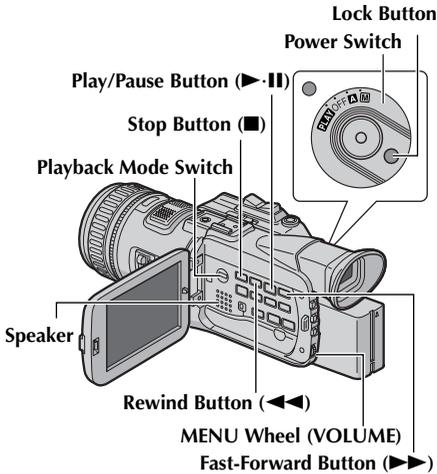

- 1 Load a cassette. (☞ pg. 18)
- 2 Set the Playback Mode Switch to "VIDEO".
- 3 Set the Power Switch to "PLAY" while pressing down the Lock Button located on the switch.
- 4 To start playback, press ▶·||.
- 5 To stop playback, press ■.
 - During Stop mode, press ◀◀ to rewind, or ▶▶ to fast-forward the tape.

NOTES:

- Clean the video heads using an optional dry cleaning cassette when:
 - No picture during playback.
 - Blocks of noise appear during playback.
 For details, ☞ pg. 79.
- If Stop mode continues for 5 minutes when power is supplied from a battery, the camcorder shuts off automatically. To turn on again, set the Power Switch to "OFF", then to "PLAY".
- The playback picture can be viewed in the LCD monitor, viewfinder or on a connected TV. (☞ pg. 26)
- You can also view the playback picture on the LCD monitor with it flipped over and pushed against the camcorder body.
- LCD monitor/viewfinder indications:
 - When power is supplied from a battery: the "☐" battery indicator is displayed. (☞ pg. 75)
 - When power is supplied from an AC outlet: the "☐" battery indicator does not appear.
- When a cable is connected to the AV connector, the sound is not heard from the speaker.

To control the speaker volume...

Rotate the MENU Wheel towards "+" to turn up the volume, or towards "-" to turn down the volume.

Still Playback

Pauses during video playback.

- 1) Press ▶·|| during playback.
- 2) To resume normal playback, press ▶·|| again.
 - If still playback continues for more than about 3 minutes, the camcorder's Stop mode is automatically engaged.
 - When ▶·|| is pressed, the image may not pause immediately while the camcorder stabilizes the still image.

Frame-By-Frame Playback

Allows frame-by-frame search during video playback. This feature is available only with a tape recorded in DV recording mode.

- 1) Press ▶·|| during playback.
- 2) Rotate the MENU Wheel toward ▲ for forward and ▼ for reverse.

Shuttle Search

Allows high-speed search in either direction during video playback.

- 1) During playback, press ►► for forward search, or ◀◀ for reverse search.
- 2) To resume normal playback, press ►||.
 - During playback, press and hold ►► or ◀◀. The search continues as long as you hold the button. Once you release the button, normal playback resumes.
 - A slight mosaic effect appears on the display during Shuttle Search. This is not a malfunction.

ATTENTION:

(DV mode only)

During Shuttle Search, parts of the picture may not be clearly visible, particularly on the left side of the screen.



Blank Search

Helps you find where you should start recording in the middle of a tape to avoid time code interruption. (☞ pg. 23)

- 1 Load a cassette. (☞ pg. 18)
- 2 Set the Playback Mode Switch to "VIDEO".
- 3 Set the Power Switch to "PLAY" while pressing down the Lock Button located on the switch.
- 4 During Stop mode, press **BLANK SEARCH**.
 - The "BLANK SEARCH" indication appears and the camcorder automatically starts reverse or forward search, then stops at the spot which is about 3 seconds of tape before the beginning of the detected blank portion.
 - To cancel Blank Search midway, press ■.



NOTES:

- Before starting Blank Search, if the current position is at a blank portion, the camcorder searches in the reverse direction. If the current position is at a recorded portion, the camcorder searches in the forward direction.
- Blank Search does not work if "HEAD CLEANING REQUIRED. USE CLEANING CASSETTE" has appeared with the tape.
- If the beginning or end of the tape is reached during Blank Search, the camcorder stops automatically.
- A blank portion which is shorter than 5 seconds of tape may not be detected.
- The detected blank portion may be located between recorded scenes. Before you start recording, make sure there is no recorded scene after the blank portion.

Slow-Motion Playback Playback Zoom Playback Special Effects

Available only with the remote control (provided). (☞ pg. 59)

Connections To A TV Or VCR

These are some basic types of connections. When making the connections, refer also to your VCR and TV instruction manuals.

To Connect A Conventional TV or VCR

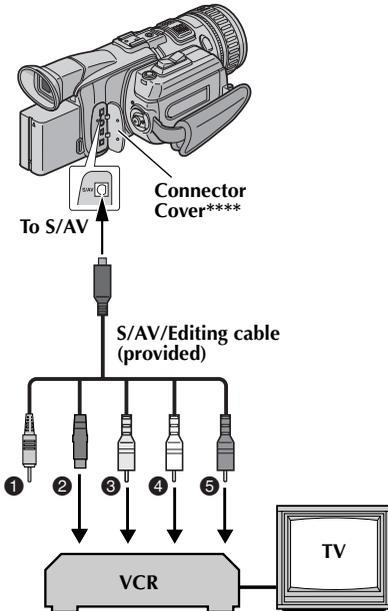

- ① Not required for connection.
- ② Black to S-VIDEO IN*
- ③ Yellow to VIDEO IN**
- ④ White to AUDIO L IN***
- ⑤ Red to AUDIO R IN***

* Connect when your TV/VCR has S-VIDEO IN and A/V input connectors. In this case, it is not necessary to connect the yellow video cable.

** Connect when your TV/VCR has only A/V input connectors.

*** Not required for watching still images only.

**** When connecting the cable, open the cover.

To Connect To A TV or VCR Equipped With The Component Video Connectors

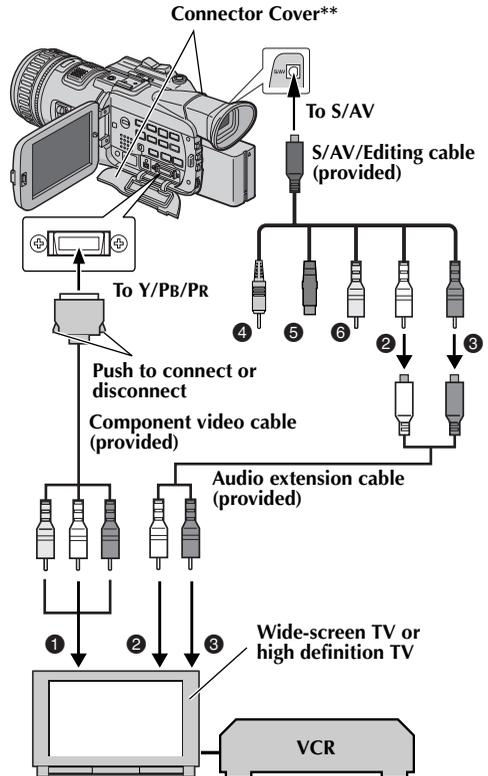

- ① To component video connectors
- ② White to AUDIO L IN*
- ③ Red to AUDIO R IN*
- ④ Not required for connection.
- ⑤ Not required for connection.
- ⑥ Not required for connection.

* Not required for watching still images only.

** When connecting the cable, open the cover.

- 1** Make sure all units are turned off.
- 2** Connect the camcorder to a TV or VCR as shown in the illustration.

If using a VCR, go to step 3.

If not, go to step 4.

- 3** Connect the VCR output to the TV input, referring to your VCR's instruction manual.
- 4 For S-video or video connection**
Set "S/VIDEO" to "16:9 TV" or "4:3 TV" depending on the aspect ratio of the TV you are connecting. (☞ pg. 35, 42)

For component video connection

Set "Y/Pb/Pr" to any picture size depending on the TV to which you are connecting.
(☞ pg. 35, 42)

- 5** Turn on the VCR and the TV.
- 6** Set the VCR to its AUX input mode, and set the TV to appropriate input mode.

To choose whether or not the following displays appear on the connected TV...

- **Date/Time**
Set "DATE/TIME" to "AUTO", "ON" or "OFF".
(☞ pg. 35, 42)
Or, press **DISPLAY** on the remote control to turn on/off the date indication.
- **Time Code**
Set "TIME CODE" to "ON" or "OFF".
(☞ pg. 35, 42)
- **Indications other than date/time and time code**
Set "ON SCREEN" to "OFF", "LCD" or "LCD/TV".
(☞ pg. 35, 42)

NOTES:

- ***It is recommended to use the AC Power Adapter/Charger as the power supply instead of the battery pack.*** (☞ pg. 13)
- *To monitor the picture and sound from the camcorder without inserting a tape or memory card, set the camcorder's Power Switch to "A" or "M", then set your TV to the appropriate input mode.*
- *Make sure you adjust the TV sound volume to its minimum level to avoid a sudden burst of sound when the camcorder is turned on.*
- *If you have a TV or speakers that are not specially shielded, do not place the speakers adjacent to the TV as interference will occur in the camcorder playback picture.*
- *During playback in HD mode, the images may not appear on the camcorder's LCD monitor or viewfinder if the component video cable is connected.*
- *When a cable is connected to the S/AV or headphone connector, sound cannot be heard from the speaker.*
- *According to the type of the connected TV and the recording mode, the playback picture may be squeezed vertically or horizontally. For details, refer to the Instructions of the TV.*

Basic Shooting (D.S.C. Snapshot)

You can use your camcorder as a Digital Still Camera for taking snapshots. Still images are stored in the memory card.

NOTE:

Before continuing, perform the procedures listed below:

- Power (☞ pg. 12)
- Loading A Memory Card (☞ pg. 19)

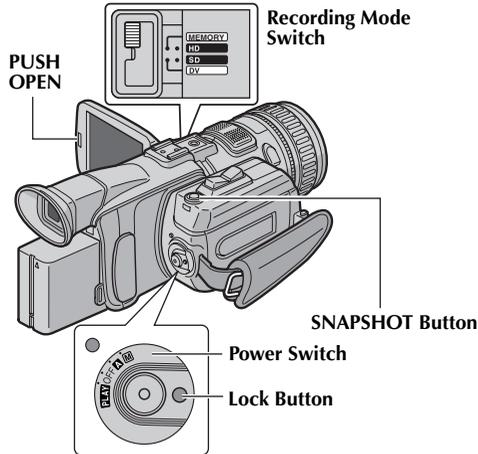

- 1 Remove the lens cap.
- 2 Press **PUSH OPEN** and open the LCD monitor fully, or pull out the viewfinder fully.
- 3 Set the Recording Mode Switch to "MEMORY".
- 4 Set the Power Switch to "A" or "M" while pressing down the Lock Button located on the switch.
- 5 Press **SNAPSHOT**. The "PHOTO" indication appears while the snapshot is being taken.
 - To check how the image looks before recording it in the memory card, press **SNAPSHOT** halfway and hold. The "●" indicator appears and stops blinking when the captured image is focused. To cancel the recording, release **SNAPSHOT**. To record it in the memory card, press **SNAPSHOT** fully.
 - Still images are recorded in the snapshot mode with no frame. There is the sound of a shutter closing.
 - To delete unwanted still images, refer to "Deleting Files" (☞ pg. 32).
 - When you do not want to hear the shutter sound, set "BEEP" to "OFF". (☞ pg. 35, 38)
 - To change the Image Size and/or Picture Quality, ☞ pg. 35, 40.

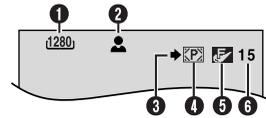

- 1 Image Size (☞ pg. 40, 86)
- 2 Focus Icon (☞ pg. 86)
- 3 Shooting Icon (☞ pg. 86)
- 4 Card Icon (☞ pg. 86)
- 5 Picture Quality (☞ pg. 40, 86)
- 6 Remaining Number Of Shots (☞ pg. 86)

NOTES:

- Even if "OIS" is set to "ON" (☞ pg. 37), the Stabilizer will be disabled.
- If Special Effects (☞ pg. 51) is engaged, certain modes are disabled during Snapshot recording. In such a case, the icon blinks.
- If shooting is not performed for approx. 5 minutes when the Power Switch is set to "A" or "M" and power is supplied from the battery pack, the camcorder shuts off automatically to save power. To perform shooting again, push back and pull out the viewfinder again or close and re-open the LCD monitor.
- The Motor Drive mode (☞ pg. 44) is disabled when the Recording Mode Switch is set to "MEMORY".
- When a cable is connected to the AV connector, the shutter sound is not heard from the speaker, however it is recorded onto the tape.
- Still images taken are compliant to DCF (Design rule for Camera File system). They do not have any compatibility with devices which are not compliant to DCF.

Normal Playback Of Images

Images shot with the camcorder are automatically numbered, then stored in numerical order in the memory card. You can view the stored images, one at a time, much like flipping through a photo album.

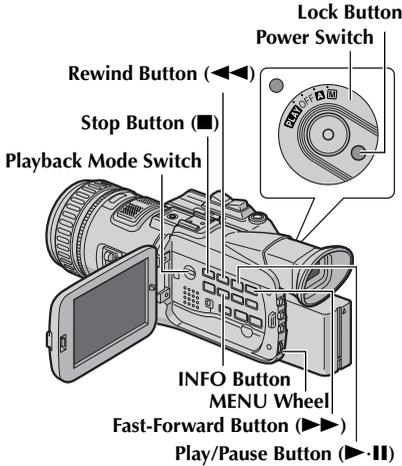

- 1 Load a memory card. (☞ pg. 19)
- 2 Set the Playback Mode Switch to "MEMORY".
- 3 Set the Power Switch to "PLAY" while pressing down the Lock Button located on the switch.
- 4 Open the LCD monitor fully, or pull out the viewfinder fully.
 - The still image which has been played back at the last time is displayed.
- 5 Press ◀◀ to display the previous file. Press ▶▶ to display the next file.
 - Pressing INFO gives you details on the displayed file. (☞ pg. 30)
 - You can also look for the desired file using Index Screen. (☞ pg. 30)
 - You can turn off the on-screen playback display. (☞ pg. 30)

NOTES:

- Even if you shoot a new image after playing back a low-numbered one, this will not overwrite an existing image, because new images are automatically stored after the last-recorded one.
- Images shot in a file size other than "640 x 480", "848 x 480", "1280 x 720" and "1280 x 960" with another devices will be displayed thumbnail images. These thumbnail images cannot be transferred to a PC.
- Images shot with devices (such as JVC GR-DVM70) that are not compatible with DCF cannot be viewed with this camcorder; "UNSUPPORTED FILE!" will be displayed.

Playback Zoom

Available only with the remote control (provided). (☞ pg. 59)

Auto Playback Of Images

You can run through all the images stored in memory card automatically.

- 1 Perform steps 1 – 4 in "Normal Playback Of Images".
- 2 Press ▶|| to start Auto Playback. Files are displayed in descending order.
 - If you press ◀◀ during Auto Playback, files are displayed in ascending order.
- 3 To end Auto Playback, press ■.

[For Normal Playback] [For Auto Playback]
To display the next image

Image playback screen (IMAGE)

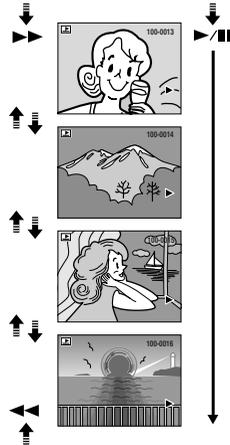

To display the previous image

Index Playback Of Files

You can view several different files stored in the memory card at a time. This browsing capability makes it easy to locate a particular file you want.

- 1 Perform steps 1 – 4 in “Normal Playback Of Images” (☞ pg. 29).
- 2 Press **INDEX**. The Index Screen of the image files appears.

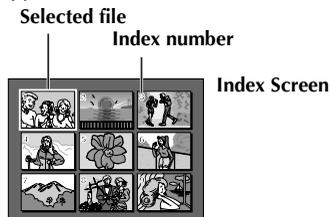

- 3 Rotate the **MENU** Wheel to move the frame to the desired file.
 - Press ◀◀ to display the previous page. Press ▶▶ to display the next page.
- 4 Press the **MENU** Wheel in. The selected file is displayed.
 - Pressing **INFO** gives you details on the displayed file. (See below.)

Viewing File Information

You can get the relevant file information by pressing the **INFO** Button during normal playback or Index Playback.

- FOLDER : Folder name (☞ pg. 33)
 FILE : File name (☞ pg. 33)
 DATE : Date the file was made
 SIZE : Image size
 QUALITY : Picture quality
 PROTECT : When set to “ON”, the file is protected from accidental erasure. (☞ pg. 31)



Information Screen

- Press the **INFO** Button again to close the Information Screen.

NOTE:

With images shot with other devices or processed on a PC, “QUALITY: ---” will be displayed.

Removing On-Screen Display

- 1 Perform steps 1 – 4 in “Normal Playback Of Images” (☞ pg. 29).
- 2 Press the **MENU** Wheel in. The Menu Screen appears.
- 3 Rotate the **MENU** Wheel to select “DISPLAY”, and press it. The Sub Menu appears.
- 4 Rotate the **MENU** Wheel to select “OFF”, and press it. The operation mode indicator, folder/file number and battery indicator (☐) disappear.
 - To display the indicators again, select “ON”.

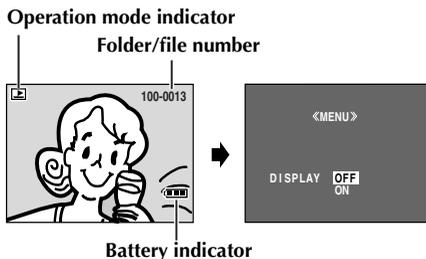

Operation mode indicator

Folder/file number

Battery indicator

Protecting Files

The Protect mode helps prevent the accidental erasure of files.

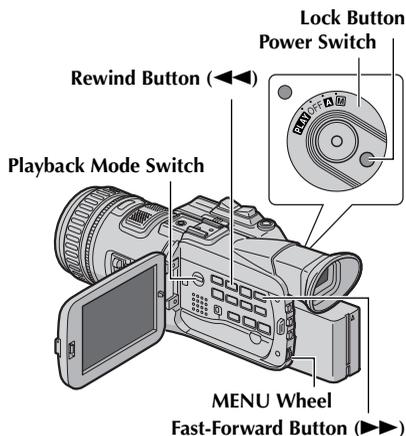

- 1** Load a memory card. (☞ pg. 19)
- 2** Set the Playback Mode Switch to "MEMORY".
- 3** Set the Power Switch to "PLAY" while pressing down the Lock Button located on the switch.
- 4** Open the LCD monitor fully, or pull out the viewfinder fully.
 - The still image which has been played back at the last time is displayed.
- 5** Press the MENU Wheel in. The Menu Screen appears.
- 6** Rotate the MENU Wheel to select "PROTECT", and press it. The Sub Menu appears.



To protect the currently displayed file

- 7** Rotate the MENU Wheel to select "CURRENT", and press it. The PROTECT screen appears.
- 8** Press ◀◀ or ▶▶ to select the desired file.
- 9** Rotate the MENU Wheel to select "EXECUTE", and press it.
 - To cancel protection, select "RETURN".
 - Repeat steps 8 and 9 for all files you want to protect.



To protect all files stored in the memory card

- 7** Rotate the MENU Wheel to select "PROT.ALL", and press it. The PROTECT screen appears.
- 8** Rotate the MENU Wheel to select "EXECUTE", and press it.
 - To cancel protection, select "RETURN".

NOTES:

- If the "Ⓞ" mark appears, the currently displayed file is protected.
- When the memory card is initialized or corrupted, even protected files are deleted. If you do not want to lose important files, transfer them to a PC and save them.

To Remove Protection

Before doing the following, perform steps 1 – 6 in "Protecting Files" in the left column.

To remove protection from the currently displayed file

- 7** Rotate the MENU Wheel to select "CURRENT", and press it. The PROTECT screen appears.
- 8** Press ◀◀ or ▶▶ to select the desired file.
- 9** Rotate the MENU Wheel to select "EXECUTE", and press it.
 - To cancel selection, select "RETURN".
 - Repeat steps 8 and 9 for all files you want to remove protection.

To remove protection from all files stored in the memory card

- 7** Rotate the **MENU** Wheel to select "CANC.ALL", and press it. The PROTECT screen appears.
- 8** Rotate the **MENU** Wheel to select "EXECUTE", and press it.
 - To cancel selection, select "RETURN".

Deleting Files

Previously stored files can be deleted either one at a time or all at once.

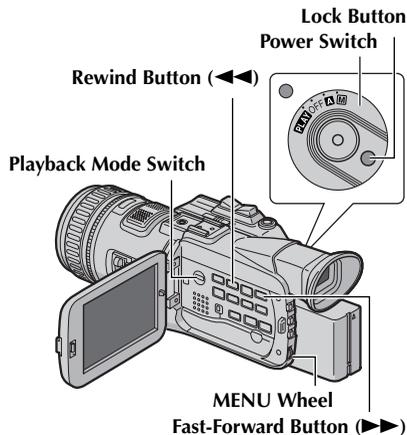

- 1** Load a memory card. (☞ pg. 19)
- 2** Set the Playback Mode Switch to "MEMORY".
- 3** Set the Power Switch to "PLAY" while pressing down the Lock Button located on the switch.
- 4** Open the LCD monitor fully, or pull out the viewfinder fully.
 - The still image which has been played back at the last time is displayed.
- 5** Press the **MENU** Wheel in. The Menu Screen appears.
- 6** Rotate the **MENU** Wheel to select "DELETE", and press it. The Sub Menu appears.

To delete the currently displayed file

- 7** Rotate the **MENU** Wheel to select "CURRENT", and press it. The DELETE screen appears.
- 8** Press ◀◀ or ▶▶ to select the desired file.
- 9** Rotate the **MENU** Wheel to select "EXECUTE", and press it.
 - To cancel deletion, select "RETURN".
 - Repeat steps **8** and **9** for all files you want to delete.



NOTE:

If the "Ⓜ" mark appears, the selected file is protected and cannot be deleted.

To delete all files stored in the memory card

- 7** Rotate the **MENU** Wheel to select "ALL", and press it. The DELETE screen appears.
- 8** Rotate the **MENU** Wheel to select "EXECUTE", and press it.
 - To cancel deletion, select "RETURN".

NOTES:

- Protected files (☞ pg. 31) cannot be deleted. To delete them, remove protection first.
- Once files are deleted, they cannot be restored. Check files before deleting.

CAUTION:

Do not remove the memory card or perform any other operation (such as turning off the camcorder) during deletion. Also, be sure to use the provided AC Power Adapter/Charger, as the memory card may be corrupted if the battery becomes exhausted during deletion. If the memory card becomes corrupted, initialize it. (☞ pg. 34)

Resetting The File Name

By resetting the file name, a new folder will be made. The new files you are going to make will be stored in the new folder. It is convenient to separate the new files from previously made files.

- 1 Load a memory card. (☞ pg. 19)
- 2 Set the Playback Mode Switch to "MEMORY".
- 3 Set the Power Switch to "PLAY" while pressing down the Lock Button located on the switch.
- 4 Open the LCD monitor fully, or pull out the viewfinder fully.
 - The still image which has been played back at the last time is displayed.
- 5 Press the **MENU** Wheel in. The Menu Screen appears.
- 6 Rotate the **MENU** Wheel to select "NO. RESET", and press it. The NO. RESET screen appears.
- 7 Rotate the **MENU** Wheel to select "EXECUTE", and press it. The new folder (such as "101JVCGR") will be made and the file made of the next shot starts from DVC00001.

Folder and File names

Each time shooting takes place, a file name is made using a number which is larger by one than the largest number of the file names which are in use. Even if you delete an image file with a number in the middle of range, the number will not be used for a new shot; a gap will remain in the numerical sequence. If the file name reaches DVC09999, a new folder (such as "101JVCGR") will be made and the file name will start again from DVC00001.

Setting Print Information (DPOF Setting)

This camcorder is compatible with the DPOF (Digital Print Order Format) standard in order to support future systems such as automatic printing. You can select one of the 2 print information settings for images stored in the memory card: "To Print All Still Images (One Print For Each)" or "To Print By Selecting Still Images And Number Of Prints".

NOTES:

- If you load a memory card already set as shown below in a printer compatible with DPOF, it will make prints of the selected still images automatically.
- To print images recorded on a tape, first dub them to a memory card. (☞ pg. 57)

To Print All Still Images (One Print For Each)

- 1 Load a memory card. (☞ pg. 19)
- 2 Set the Playback Mode Switch to "MEMORY".
- 3 Set the Power Switch to "PLAY" while pressing down the Lock Button located on the switch.
- 4 Open the LCD monitor fully, or pull out the viewfinder fully. The still image which has been played back at the last time is displayed.
- 5 Press the **MENU** Wheel in. The Menu Screen appears.
- 6 Rotate the **MENU** Wheel to select "DPOF", and press it. The Sub Menu appears.
- 7 Rotate the **MENU** Wheel to select "ALL 1", and press it. The DPOF screen appears.
- 8 Rotate the **MENU** Wheel to select "EXECUTE", and press it. The normal playback screen appears.
 - To cancel selection, select "RETURN".



To Print By Selecting Still Images And Number Of Prints

- 1 Perform steps 1 – 6 in “To Print All Still Images (One Print For Each)” (pg. 33).
- 2 Rotate the **MENU** Wheel to select “CURRENT”, and press it. The DPOF screen appears.
 
- 3 Press ◀◀ or ▶▶ to select the desired file.
- 4 Rotate the **MENU** Wheel to select the number indication (00), and press it.
- 5 Select the number of prints by rotating the **MENU** Wheel towards “▲” to increase number, or towards “▼” to decrease the number, and press it.
 - Repeat steps 3 through 5 for the desired number of prints.
 - The number of prints can be set up to 15.
 - To correct the number of prints, select the image again and change the number.
- 6 Rotate the **MENU** Wheel to select “EXECUTE”, and press it. The “SAVE?” appears.
 - If you did not change any settings in step 3 through 5, the Menu Screen reappears.
- 7 Rotate the **MENU** Wheel to select “EXECUTE” to save the setting you have just made, and press it.
 - To cancel selection, select “CANCEL”.

To Reset The Number Of Prints

- 1 Perform steps 1 – 6 in “To Print All Still Images (One Print For Each)” (pg. 33).
- 2 Rotate the **MENU** Wheel to select “RESET”, and press it. The DPOF screen appears.
- 3 Rotate the **MENU** Wheel to select “EXECUTE”, and press it. The normal playback screen appears.
 - To cancel selection, select “RETURN”.
 - The number of prints is reset to 0 for all still images.

CAUTION:

While performing the above, never disconnect power, as this may cause the memory card to be corrupted.

Initializing A Memory Card

You can initialize a memory card any time. After initializing, all files and data stored in the memory card, including those which have been protected, are cleared.

- 1 Set the Playback Mode Switch to “MEMORY”.
- 2 Set the Power Switch to “PLAY” while pressing down the Lock Button located on the switch.
- 3 Open the LCD monitor fully, or pull out the viewfinder fully.
- 4 Press the **MENU** Wheel in. The Menu Screen appears.
 
- 5 Rotate the **MENU** Wheel to select “FORMAT”, and press it. The FORMAT screen appears.
 
- 6 Rotate the **MENU** Wheel to select “EXECUTE”, and press it. The memory card is initialized.
 - When initialization is finished, “NO IMAGES STORED” appears.
 - To cancel initialization, select “RETURN”.

CAUTION:

Do not perform any other operation (such as turning off the camcorder) during initialization. Also, be sure to use the provided AC Power Adapter/Charger, as the memory card may be corrupted if the battery becomes exhausted during initialization.

Changing The Menu Settings

This camcorder is equipped with an easy-to-use, on-screen menu system that simplifies many of the more detailed camcorder settings. (☞ pg. 36 – 42)

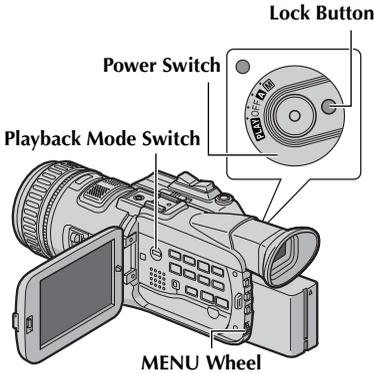

1 For Video and D.S.C. Recording Menus:

Set the Power Switch to “**M**” while pressing down the Lock Button located on the switch.

For Video Playback Menus:

- 1) Set the Playback Mode Switch to “VIDEO”.
- 2) Set the Power Switch to “**PLAY**” while pressing down the Lock Button located on the switch.

For D.S.C. Playback Menus:

For details, refer to “D.S.C. PLAYBACK” (☞ pg. 29).

2 Open the LCD monitor fully, or pull out the viewfinder fully.

3 Press the MENU Wheel in. The Menu Screen appears.



Menu Screen for Video and D.S.C. Recording Menu

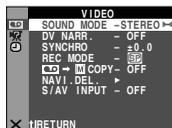

Menu Screen for Video Playback Menu

4 Rotate the MENU Wheel to select the desired function, and press it. The selected function menu appears.

5 Rotate the MENU Wheel to select the desired function, and press it. The Sub Menu appears.

Example: **A** CAMERA Menu

Selected menu icon blinks.

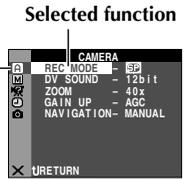

6 Rotate the MENU Wheel to select the desired parameter.

Sub Menu



7 Press the MENU Wheel in. Selection is complete.

- Repeat the procedure if you wish to set other function menus.



8 Press the MENU Wheel in. The Menu Screen returns.

- Repeat the procedure if you wish to set other function menus.

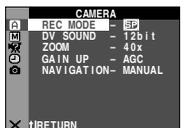

9 Press the MENU Wheel in again. The Menu Screen closes.

NOTES:

- The “**A**” settings are effective when the Power Switch is set to both “**A**” and “**M**”. However, the menu settings can be changed only when the Power Switch is set to “**M**”.
- The “**M**” settings are effective only when the Power Switch is set to “**M**”.
- The “**PLAY**” functions which are set when the Power Switch is set to “**M**” are also applied when the Power Switch is set to “**PLAY**”.
- The “**EP**” (CAMERA DISPLAY) settings are effective even when the Power Switch is set to “**A**”. However, the menu settings can be changed only when the Power Switch is set to “**M**”.
- The “**EP**” (CAMERA DISPLAY) settings are effective only for shooting except “BRIGHT”.
- The “**EP**” (VIDEO DISPLAY) settings are effective only for video playback except “BRIGHT”.
- The date indication can also be turned on/off by pressing the **DISPLAY** Button on the remote control (provided). (☞ pg. 27, 54, 63)

Camera Menu

CAMERA

Recording mode

Allows you to set the recording mode (SP or LP) depending on your preference.

REC MODE (Factory-preset: **SP**)

SP: Standard Play

LP: Long Play—more economical, providing 1.5 times the recording time.

NOTES:

- *Audio Dubbing* (☞ pg. 60) and *Insert Editing* (☞ pg. 61) are possible on tapes recorded in the SP mode.
- If the recording mode is switched during recording, the playback picture will be blurred at the switching point.
- It is recommended that tapes recorded in the LP mode on this camcorder be played back on this camcorder.
- During playback of a tape recorded on another camcorder, blocks of noise may appear or there may be momentary pauses in the sound.

Sound mode

DV SOUND (Factory-preset: **12 bit**)

12 bit: Enables video recording of stereo sound on four separate channels, and is recommended for use when performing Audio Dubbing. (Equivalent to the 32 kHz mode of previous models)

16 bit: Enables video recording of stereo sound on two separate channels. (Equivalent to the 48 kHz mode of previous models)

Zooming

ZOOM (Factory-preset: **40X**)

10X: When set to “10X”, only the optical zoom magnification is engaged.

40X*: Allows you to use the Digital Zoom. By digitally processing and magnifying images, zooming is possible from 10X (the optical zoom limit), to a maximum of 40X digital magnification.

200X*: Allows you to use the Digital Zoom. By digitally processing and magnifying images, zooming is possible from 10X (the optical zoom limit), to a maximum of 200X digital magnification.

* Not available when the Recording Mode Switch is set to “HD” or “MEMORY”.

Gain up

GAIN UP (Factory-preset: **AGC**)

OFF: Allows you to shoot dark scenes with no picture brightness adjustment.

AGC: The overall appearance may be grainy, but the image is bright.

Navigation time

NAVIGATION (Factory-preset: **MANUAL**)

5SEC / 15SEC / 30SEC / 60SEC:

The captured image is stored in the memory card as a thumbnail image when the recording time is over the navigation time.

For example, “5SEC” is suitable to record short scenes with the thumbnail images. (☞ pg. 52) However, the stored thumbnail images may take up a lot of memory. In this case, using the memory card with large capacity is recommended.

MANUAL: Enables thumbnail images to be made manually. (☞ pg. 52)

Manual Menu

MANUAL

Optical Image Stabilization

To compensate for unstable images caused by camera-shake, particularly at high magnification.

OIS (Factory-preset: **ON**)

OFF / ON 

NOTES:

- *Accurate stabilization may not be possible if hand shake is excessive, or under the following conditions:*
 - When shooting subjects with vertical or horizontal stripes.
 - When shooting dark or dim subjects.
 - When shooting subjects with excessive backlighting.
 - When shooting scenes with movement in various directions.
 - When shooting scenes with low-contrast backgrounds.
- Switch off this mode when recording with the camcorder on a tripod.
- The " " indicator blinks or goes out if the Stabilizer cannot be used.

Self-Timer

For details, refer to "Self-Timer" ( pg. 43).

SELF-TIMER (Factory-preset: **OFF**)

OFF / ON 

5-Second Recording

Record a vacation or an important event in 5-second clips to keep the action moving. This function is available only when the Recording Mode Switch is set to "DV".

- 1 Set "5S" to "5S". ( pg. 35)
 - "5S" appears.
- 2 Press the Recording Start/Stop Button to start recording, and after 5 seconds the camcorder enters Record-Standby mode automatically.
 - Even if you press the Recording Start/Stop Button again within 5 seconds after recording starts, Record-Standby mode is not engaged.
- 3 To exit the 5S mode, select "OFF" in step 1.

To take a snapshot in the 5-second recording mode...

Instead of pressing the Recording Start/Stop Button in step 2, press **SNAPSHOT**. The camcorder records a 5-second still. When "5S" is set to "Anim.", this function is not available.

5S (Factory-preset: **OFF**)

OFF: Disables 5-Second Recording.

5S: Enables 5-Second Recording.

Anim.: Allows you to record a few frames only. By using an inanimate object and changing its position between shots, you can record the subject as though it is moving.

NOTE:

When "5S" is set to "Anim.", the 5-Second Recording mode is not available. Animation recording of a few frames only is taken instead.

Maximum telephoto setting

Usually the distance to a subject where the lens is in focus depends on the zoom magnification. Unless there is a distance more than 1 m (3.3 ft) to the subject, the lens is out of focus at the maximum telephoto setting.

TELE MACRO (Factory-preset: **OFF**)

OFF: Disables the function.

ON: When set to "ON", you can shoot a subject as large as possible at a distance of approx. 60 cm (2 ft).

NOTE:

Depending on the zoom position, the lens may go out of focus.

Wide mode**DV WIDE** (Factory-preset: **OFF**)

OFF: Records with no change in the screen ratio. For playback on a TV with a normal screen ratio.

SQUEEZE*: For playback on TVs with an aspect ratio of 16:9. Naturally expands the image to fit the screen without distortion. The  indicator appears. When using this mode, refer to your wide-screen TV's instruction manual. During playback/recording on 4:3 TVs/LCD monitor/viewfinder, the image is elongated vertically.

D.WIDE*: The  indicator appears. The zoom range is extended beyond the maximum optical zoom wide angle range. This mode's wide angle setting is equivalent to using a 0.7X wide conversion lens. Zooming is possible from 0.7X to a magnification set in CAMERA Menu. This mode is suitable for shooting in a small room.

* Not available when the Recording Mode Switch is set to "HD" or "MEMORY".

Wind cut**WIND CUT** (Factory-preset: **OFF**)

OFF: Disengages the function.

ON : Helps cut down on noise created by wind. The "" indicator appears. The quality of the sound will change. This is normal.

System Menu**SYSTEM****Beep, melody and shutter sound****BEEP** (Factory-preset: **OFF**)

OFF: Even though not heard while shooting, shutter sound is recorded on the tape.

BEEP: The beep sounds when the power is turned on or off, and at the beginning and end of recording. It also activates the shutter sound effect. (☞ pg. 28, 44)

MELODY: Instead of a beep, a melody sounds when any operation is performed. It also activates the shutter sound effect. (☞ pg. 28, 44)

Tally lamp setting**TALLY** (Factory-preset: **ON**)

OFF: The tally lamp remains off at all times.

ON: The tally lamp comes on to signal the start of recording.

Remote control setting

For details, refer to "USING THE REMOTE CONTROL UNIT" (☞ pg. 58).

REMOTE (Factory-preset: **ON**)

OFF: Disables the remote control operations.

ON: Enables the remote control operations.

Priority setting

When the viewfinder is pulled out while the LCD monitor is opened, you can select which one to use.

PRIORITY (Factory-preset: **LCD**)

LCD: Allows you to use the LCD monitor.

FINDER: Allows you to use the viewfinder.

BOTH: Allows you to use both the LCD and viewfinder.

Component video output setting

When connecting the camcorder to a TV or video unit equipped with component video inputs (☞ pg. 26), select the output picture size depending on the connected TV or video unit.

Y/Pb/Pr (Factory-preset: **NO CONV.**)

NO CONV.: Outputs with the original size.

Signals are output in 480p during recording.

720 to 1080: Converts to 1080i. Signals are output in 480p during recording.

ALL to 480p: Converts to 480p.

ALL to 480i: Converts to 480i.

ALL to 1080: Converts to 1080i. Select this setting if your TV is compatible to 1080i input only.

Signals are not output during recording (in any mode) or playback in DV mode.

NOTE:

Signals are output in 480i during recording or playback in DV mode regardless of the output setting.

S-Video output setting

When connecting the camcorder to a 4:3 TV or wide-screen TV using the S/AV/Editing cable (☞ pg. 26), select the aspect ratio of the connected TV.

S/VIDEO (Factory-preset: **4:3 TV**)

16:9 TV: For a TV which has an aspect ratio of 16:9.

4:3 TV: For a TV which has an aspect ratio of 4:3.

i.LINK output setting

During digital tape dubbing, select whether the video signal outputs according to the Switch setting.

i.LINK OUT (Factory-preset: **SW**)

SW: Normally, set to this position. Outputs the DV or MPEG2 format signal selected with the i.LINK OUT Switch.

AUTO: For future use. If the connected video unit automatically detects the input signal via an i.LINK connector, set to "AUTO".

Resetting menu settings

CAM RESET

EXECUTE: Resets all settings to the factory-preset.

RETURN: Does not reset all settings to the factory-preset.

Display Menu

CAMERA DISPLAY

Brightness adjustment of the display

BRIGHT

For details, refer to "Brightness Adjustment Of The Display" (☞ pg. 15).

Display setting

ON SCREEN (Factory-preset: **LCD/TV**)

LCD: Keeps the camcorder's display (except the date, time and time code) from appearing on the connected TV screen.

LCD/TV: Makes the camcorder's display appear on screen when the camcorder is connected to a TV.

Date and time display setting

DATE/TIME (Factory-preset: **AUTO**)

OFF: The date/time does not appear.

AUTO: Displays the date/time for approx. 5 seconds when the Power Switch is set from "OFF" to "A" or "M".

ON: The date/time is always displayed.

Time code setting

TIME CODE (Factory-preset: **OFF**)

OFF: Time code is not displayed.

ON: Time code is displayed on the camcorder and on the connected TV. Frame numbers are not displayed during recording.

Clock adjustment

CLOCK ADJ.

Allows you to set the current date and time. (☞ pg. 17)

DSC Menu

DSC

Picture quality

The Picture Quality mode can be selected to best match your needs. Two Picture Quality modes are available: FINE () and STANDARD () (in order of quality).

QUALITY (Factory-preset: **FINE**)
FINE / STANDARD

NOTE:

The number of storable images depends on the selected picture quality as well as the composition of the subjects in the images and the type of memory card being used. (☞ pg. 44)

Image size

The Image Size mode can be selected to best match your needs.

IMAGE SIZE (Factory-preset: **1280 x 960**)
640 x 480 / 1280 x 960

NOTES:

- The settings can be changed only when the Recording Mode Switch is set to "MEMORY".
- To shoot still images in 848 x 480 pixels or 1280 x 780 pixels, set "REC SELECT" to "/ /  (☞ "Recording media selection"), set the Recording Mode Switch to "SD" or "HD". (☞ "Snapshot (For Video Recording)", pg. 44)

Approximate Number of Storable Images

Image Size/Picture Quality	SD Memory Card			
	8 MB**	16 MB*	32 MB*	64 MB*
640 x 480/FINE	30	68	144	297
640 x 480/STANDARD	80	178	376	772
848 x 480/FINE	25	55	117	241
848 x 480/STANDARD	66	148	313	643
1280 x 720/FINE	10	22	48	99
1280 x 720/STANDARD	26	59	125	257
1280 x 960/FINE	7	17	36	74
1280 x 960/STANDARD	20	44	94	193

Image Size/Picture Quality	MultiMediaCard		
	8 MB*	16 MB*	32 MB*
640 x 480/FINE	36	74	149
640 x 480/STANDARD	95	192	388
848 x 480/FINE	29	60	121
848 x 480/STANDARD	79	160	323
1280 x 720/FINE	12	24	49
1280 x 720/STANDARD	31	64	129
1280 x 960/FINE	9	18	37
1280 x 960/STANDARD	23	48	97

* Optional

** Provided

Recording media selection

REC SELECT (Factory-preset: )

 : When Snapshot recording is performed with the Recording Mode Switch set to "HD", "SD" or "DV", still images are recorded only onto the tape.

/ / : When Snapshot recording is performed with the Recording Mode Switch set to "HD", "SD" or "DV", still images are recorded not only onto the tape but also in the memory card (1280 x 720 pixels in HD mode, 848 x 480 pixels in SD mode, 640 x 480 pixels in DV mode).

Video Menu

VIDEO

Playback sound

During tape playback, the camcorder detects the sound mode in which the recording was made, and plays the sound back. Select the type of sound to accompany your playback picture. According to the menu access explanation on page 35, select "SOUND MODE" or "DV NARR." from the Menu Screen and set it to the desired parameter.

SOUND MODE (Factory-preset: **STEREO**) 

STEREO : Sound is output on both "L" and "R" channels in stereo.

SOUND L : Sound from the "L" channel is output.

SOUND R : Sound from the "R" channel is output.

DV NARR. (Factory-preset: **OFF**)

OFF: Original sound is output on both "L" and "R" channels in stereo.

ON: Dubbed sound is output on both "L" and "R" channels in stereo.

MIX: Original and dubbed sounds are combined and output in stereo on both "L" and "R" channels.

NOTES:

- The "SOUND MODE" setting is available for both 12-bit and 16-bit sound. (In previous models' functions, "12-bit" is called "32 kHz" and "16-bit" is called "48 kHz".)
- The camcorder cannot detect the sound mode in which the recording was made during fast-forward or rewind. During playback the sound mode is displayed in the upper left corner.

Synchro adjustment

For details, refer to "For More Accurate Editing" (☞ pg. 66).

SYNCHRO

(Factory-preset: **±0.0**)

Recording mode

Allows you to set the video recording mode (SP or LP) depending on your preference. It is recommended you use "REC MODE" in VIDEO Menu when using this camcorder as a recorder during dubbing. (☞ pg. 54, 56)

REC MODE

(Factory-preset: **SP**)

SP / LP

NOTE:

"REC MODE" can be set when the Power Switch is set to "PLAY" or "M".

Dubbing from tape to memory card

  **COPY**

(Factory-preset: **OFF**)

OFF: When the **SNAPSHOT** button is pressed during tape playback, the playback image pauses and normal playback will resume after approximately 6 seconds. (The still image is not recorded.)

ON: Enables dubbing of images recorded on a tape to a memory card. (☞ pg. 57)

Deleting thumbnail images

For details, refer to "To delete thumbnail images" (☞ pg. 53).

NAVI.DEL.

IMAGE SEL. / TAPE SEL. / ALL / RETURN

S-Video/AV input

S/AV INPUT

(Factory-preset: **OFF**)

OFF: Enables audio/video signal output to a TV, VCR, etc. via the S/AV connector. (☞ pg. 26, 56)

A/V IN: Enables audio and video signal input from the S/AV connector. (☞ pg. 54)

S IN: Enables audio and S-video signal input from the S/AV connector.

System Menu

SYSTEM

Each setting is linked with "F2", which appears when the Power Switch is set to "M". (☞ pg. 35) The parameters are the same as in the description on page 38.

- BEEP** (Factory-preset: **OFF**)
OFF / BEEP / MELODY
- TALLY** (Factory-preset: **ON**)
OFF / ON
- REMOTE** (Factory-preset: **ON**)
OFF / ON
- PRIORITY** (Factory-preset: **LCD**)
LCD / FINDER / BOTH
- Y/Pb/Pr** (Factory-preset: **NO CONV.**)
NO CONV. / 720 to 1080 / ALL to 480p / ALL to 480i / ALL to 1080
- S/VIDEO** (Factory-preset: **4:3 TV**)
16:9 TV / 4:3 TV
- i.LINK OUT** (Factory-preset: **SW**)
SW / AUTO
- CAM RESET**
EXECUTE / RETURN

Display Menu

VIDEO DISPLAY

The parameters (except "OFF" in ON SCREEN settings) are the same as in the description on page 39.

Brightness adjustment of the display

BRIGHT

For details, refer to "Brightness Adjustment Of The Display" (☞ pg. 15).

- ON SCREEN** (Factory-preset: **LCD**)
OFF / LCD / LCD/TV
 When set to "OFF", the camcorder's display disappears.
- DATE/TIME** (Factory-preset: **OFF**)
OFF / AUTO / ON

When set to "AUTO", the date/time are displayed in the following cases:

- When playback starts. The camcorder displays the date/time when scenes are recorded.
- When the date is changed during playback.

TIME CODE (Factory-preset: **OFF**)
OFF / ON

NOTE:

The date indication can also be turned on/off by pressing the **DISPLAY** Button on the remote control (provided). (☞ pg. 27, 54, 63)

Display

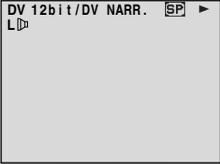
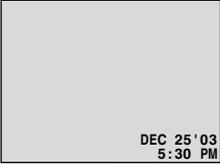
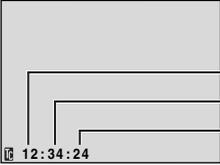
ON SCREEN Setting:
 For playback mode, playback sound, tape speed and tape running during video playback.

DATE/TIME Setting:
 For date/time.

TIME CODE Setting:
 For time code.

Minutes
 Seconds
 Frames*

* 30 frames = 1 second

Self-Timer

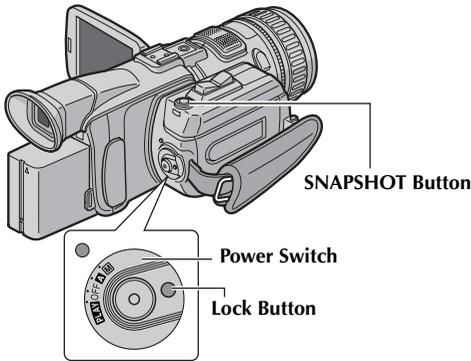

Once the camcorder is set, the camcorder operator can become part of the scene in a more natural way, adding the final touch to a memorable picture.

- 1 Set the Power Switch to "M" while pressing down the Lock Button located on the switch.
- 2 Open the LCD monitor fully, or pull out the viewfinder fully.
 - You can tilt the LCD monitor upward to 180° so that it faces forward and view yourself while self-recording with the viewfinder pushed back.

- 3 Set "SELF-TIMER" to "ON". (☞ pg. 35, 37)

- 4 To engage the Self-Timer for video recording, press the Recording Start/Stop Button.

- After 15 seconds, the beep sounds and video recording starts.

To stop Self-Timer recording, press the Recording Start/Stop Button again.

- The camcorder re-enters Record-Standby mode.

OR

- 4 Press **SNAPSHOT**.

- After 15 seconds, the beep sounds and snapshot recording starts. After that, the camcorder re-enters Record-Standby mode.

- 5 To end Self-Timer recording, select "OFF" in step 3.

NOTE:

If "BEEP" and "TALLY" are set to "OFF" (☞ pg. 38), the beep does not sound and the tally lamp does not light.

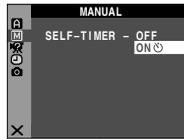
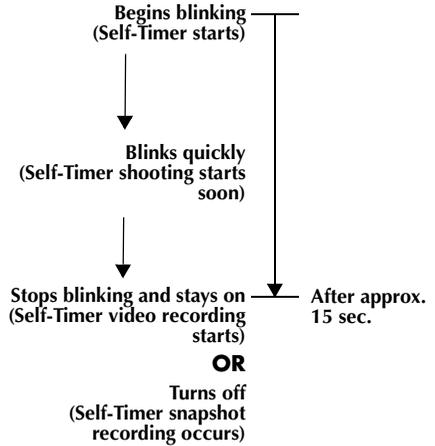
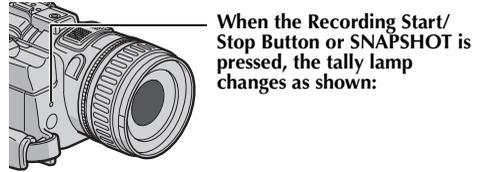

Iris Lock

Like the pupil of the human eye, the iris contracts in well-lit environments to keep too much light from entering, and dilates in dim environments to allow in more light.

Use this function in the following situations:

- When shooting a moving subject.
- When the distance to the subject changes (so its size in the LCD monitor or the viewfinder changes), such as when the subject is backing away.
- When shooting on a reflective natural background such as at the beach or when skiing.
- When shooting objects under a spotlight.
- When zooming.

When the subject is close, keep the iris locked. Even when the subject moves away from you, the image will not darken or brighten.

1 Perform steps **1** to **3** of “Exposure Control”.

- The exposure control indicator appears.

2 Adjust zoom so that the subject fills the LCD monitor or the viewfinder, then press and hold the **EXPOSURE** Wheel for over 2 seconds. The exposure control indicator and the “**L**” indication appear.



Iris Lock Indicator

To return to automatic iris control...

Press the **EXPOSURE** Wheel in. Or, set the Power Switch to “**A**”.

- The exposure control indicator and “**L**” disappear.

To lock the exposure control and the iris...

Adjust the exposure by rotating the **EXPOSURE** Wheel in step **4** of “Exposure Control”. Then lock the iris in step **2** of “Iris Lock”.

Backlight Compensation

Backlight compensation brightens the subject quickly.

Press **BACK LIGHT**. The  indicator is displayed and the subject is brightened. If pressed again,  disappears and the brightness returns to the previous level.

- Using the **BACK LIGHT** Button may cause the light around the subject to become too bright and the subject to become white.
- Backlight compensations is also available when the Power Switch is set to “**A**”.

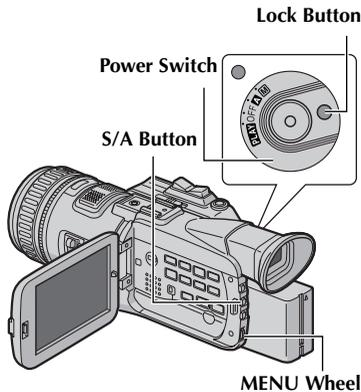

To return to automatic iris adjustment...
Press S/A. Or, set the Power Switch to "A".

Auto Focus

The camcorder's Full Range AF system offers continuous shooting ability from close-up (as close as approx. 5 cm (2") to the subject) to infinity.

Focus detection zone

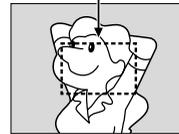

However, correct focus may not be obtainable in the situations listed below (in these cases perform "Manual Focus"):

- When two subjects overlap in the same scene.
- When illumination is low.*
- When the subject has no contrast (difference in brightness and darkness), such as a flat, one-color wall, or a clear, blue sky.*
- When a dark object is barely visible in the LCD monitor or the viewfinder.*
- When the scene contains minute patterns or identical patterns that are regularly repeated.
- When the scene is affected by sunbeams or light reflecting off the surface of a body of water.
- When shooting a scene with a high-contrast background.

* The following low-contrast warnings appear blinking: ▲, ◀, ▶ and ♀

NOTES:

- If the lens is smeared or blurred, accurate focusing is not possible. Keep the lens clean. (☞ pg. 81)
When condensation occurs, wipe with a soft cloth or wait for it to dry naturally.
- When shooting a subject close to the lens, zoom out first. (☞ pg. 22) If zoomed-in in the auto focus mode, the camcorder may automatically zoom out depending on the distance between the camcorder and the subject. This will not occur when "TELE MACRO" is set to "ON". (☞ pg. 37)

Manual Shutter Speed Adjustment

Changing the shutter speed manually allows a fast-moving subject to be shot as if it is stationary, or to be intentionally blurred for vivid playback.

- 1 Set the Power Switch to "M" while pressing down the Lock Button located on the Switch.
- 2 Open the LCD monitor fully, or pull out the viewfinder fully.
- 3 Press S/A.
 - The shutter speed level indicator appears.
- 4 For the fast shutter speed, rotate the MENU Wheel toward "▲" (fastest 1/1000 sec.).
For the slow shutter speed, rotate the MENU Wheel toward "▼" (slowest 1/15 sec.).

To return to automatic shutter speed adjustment...
Press S/A twice. Or, set the Power Switch to "A".

Manual Iris Adjustment

Adjusting the iris manually provides an image special effect by changing the range of focusing.

- 1 Set the Power Switch to "M" while pressing down the Lock Button located on the Switch.
- 2 Open the LCD monitor fully, or pull out the viewfinder fully.
- 3 Press S/A twice.
 - The iris level indicator appears.
- 4 To close the iris, rotate the MENU Wheel toward "▲" (maximum F 22.0). To open the iris, rotate the MENU Wheel towards "▼" (minimum F 1.8).
 - Closing the iris (increasing the value) enables focusing on both a subject and background.
 - Opening the iris (decreasing the value) allows appropriate brightness in poor lighting conditions, while the range of focusing will decrease.

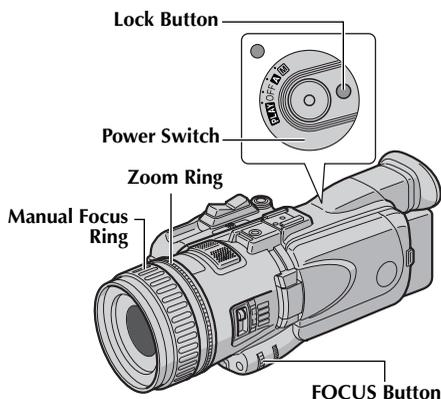

Manual Focus

NOTE:

If you are using the viewfinder, you should already have performed "Viewfinder Adjustment" (☞ pg. 15).

- 1 Set the Power Switch to "M" while pressing down the Lock Button located on the switch.
- 2 Press **FOCUS**. The manual focus indicator appears.
- 3 To focus on a further subject, rotate the Manual Focus Ring counterclockwise.

While focusing on a further subject



To focus on a nearer subject, rotate the Manual Focus Ring clockwise.

While focusing on a nearer subject



To reset to Auto Focus...

Press **FOCUS** or set the Power Switch to "A".

NOTES:

- Be sure to focus the lens in the maximum telephoto position when you use the Manual Focus mode. If you focus in on a subject in the wide-angle position, sharply focused images cannot be obtained when zoomed up because the depth-of-field is reduced at longer focal lengths.
- When the focus level cannot be adjusted any further or closer, "▲" or "●" will blink.

Manual Zooming

Zooming manually using the Zoom Ring enables controlling the shooting angle or zooming speed to your preference.

- 1 Set the Power Switch to "M" while pressing down the Lock Button located on the switch.
- 2 **Zoom In**
Rotate the Zoom Ring counterclockwise.
Zoom Out
Rotate the Zoom Ring clockwise.

NOTE:

Digital zoom cannot be used when the Recording Mode Switch is set to "HD" or "MEMORY".

(☞ pg. 16)

White Balance Adjustment

The white balance that refers to the correctness of color reproduction under various lighting. If the white balance is correct, all other colors will be accurately reproduced.

The white balance is usually adjusted automatically. However, more advanced camcorder operators control this function manually to achieve a more professional color/tint reproduction.

AUTO: White balance is adjusted automatically.

 **MWB:** Adjust the white balance manually when shooting under various types of lighting. (☞ "Manual White Balance Adjustment", pg. 49)

 **FINE:** Outdoors on a sunny day.

 **CLOUD:** Outdoors on a cloudy day.

 **HALOGEN:** A video light or similar type of lighting is used.

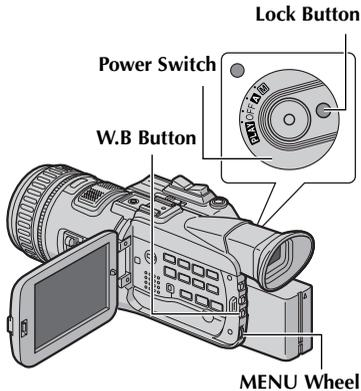

- 1** Set the Power Switch to "⏻" while pressing down the Lock Button located on the Switch.
- 2** Open the LCD monitor fully, or pull out the viewfinder fully.
- 3** Press **W.B.** The WHITE BALANCE screen appears.
- 4** Rotate the **MENU** Wheel to select the desired mode, and press it.
 - The selected mode indicator except "AUTO" appears.
 - If you select "  MWB", refer to "Manual White Balance Adjustment".
- 5** Press the **MENU** Wheel in. The white balance adjustment is complete.
 - The selected mode indicator except "AUTO" appears.

To return to automatic white balance...

Select "AUTO" in step 4. Or, set the Power Switch to "⏻".

NOTE:

White balance cannot be used when "Special Effects" is set to "SEPIA" or "MONOTONE".

(☞ pg. 51)

Manual White Balance Adjustment

Adjust the white balance manually when shooting under various types of lighting.

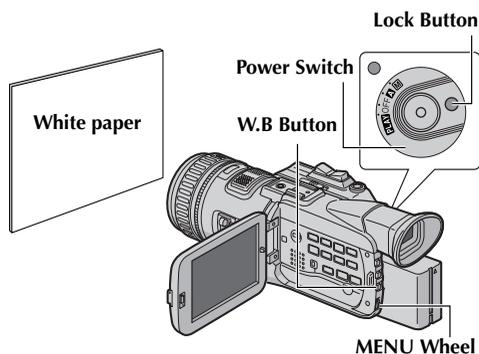

NOTES:

- In step 5, it may be difficult to focus on the white paper. In such a case, adjust focus manually. (☞ pg. 47)
- A subject can be shot under various types of lighting conditions indoors (natural, fluorescent, candlelight, etc.). Because the color temperature is different depending on the light source, the subject tint will differ depending on the white balance settings. Use this function for a more natural result.
- Once you adjust white balance manually, the setting is retained even if the power is turned off or the battery removed.

- 1 Set the Power Switch to “M” while pressing down the Lock Button located on the switch.
- 2 Open the LCD monitor fully, or pull out the viewfinder fully.
- 3 Press **W.B.** The WHITE BALANCE screen appears.
- 4 Rotate the **MENU** Wheel to select “MWB”, and press it.
- 5 Hold a sheet of plain white paper in front of the subject. Adjust zoom or position yourself so that the white paper fills the screen.
- 6 Press the **MENU** Wheel in until  begins blinking rapidly. When the setting is completed,  resumes normal blinking.
- 7 Press the **MENU** Wheel in. The Menu Screen closes and the Manual White Balance indicator  is displayed.

Wipe Or Fader Effects

Wipe/Fader effects let you make pro-style scene transitions. Use them to spice up the transition from one scene to the next.

Wipe or Fader works when video recording is started or stopped.

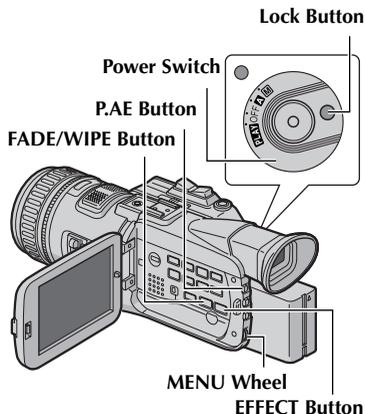

There are 9 types of Fader/Wipe Effects for scene transition.

WH **FADER-WHITE**: Fade in or out with a white screen.

BK **FADER-BLACK**: Fade in or out with a black screen.

BW **FADER-B.W**: Fade in to a color screen from a black and white screen, or fade out from color to black and white.

☐ **WIPE – CORNER**: Wipe in on a black screen from the upper right to the lower left corner, or wipe out from lower left to upper right, leaving a black screen.

☐ **WIPE – WINDOW**: The scene starts in the center of a black screen and wipes in toward the corners, or comes in from the corners, gradually wiping out to the center.

☐ **WIPE – SLIDE**: Wipe in from right to left, or wipe out from left to right.

☐ **WIPE – DOOR**: Wipe in as the two halves of a black screen open to the left and right, revealing the scene, or wipe out and the black screen reappears from left and right to cover the scene.

☐ **WIPE – SCROLL**: The scene wipes in from the bottom to the top of a black screen, or wipes out from top to bottom, leaving a black screen.

☐ **WIPE – SHUTTER**: Wipe in from the center of a black screen toward the top and bottom, or wipe out from the top and bottom toward the center leaving a black screen.

- 1 Set the Power Switch to “**☐**” while pressing down the Lock Button located on the switch.
- 2 Open the LCD monitor fully, or pull out the viewfinder fully.
- 3 Press **FADE/WIPE**. The WIPE/FADER screen appears.
- 4 **To activate the Fade-in or Wipe-in:**
Rotate the **MENU Wheel** to select the desired effect and press it during Record-Standby mode.
 - The selected effect indicator appears.**To activate the Fade-out or Wipe-out:**
Rotate the **MENU Wheel** to select the desired effect and press it during recording.
 - The selected effect indicator appears.
- 5 Press the Recording Start/Stop Button to activate the Fade-in/out or Wipe-in/out.

To deactivate the selected effect...

Select “OFF” in step 4. Or, set the Power Switch to “**A**”.

NOTES:

- You can extend the length of a Wipe or Fader by pressing and holding the Recording Start/Stop Button.
- Wipe Effects is not activated when the recording mode is set to “HD”.

IMPORTANT:

Some Wipe/Fader Effects cannot be used with certain modes of Program AE or Special Effects. If an unusable Wipe/Fader Effect is selected, its indicator blinks in blue or goes out.

Program AE

Program AE allows you to shoot images according to various situations.

SPORTS

(Variable Shutter Speed: 1/250 – 1/1000)

This setting allows various fast-moving images to be captured one frame at a time, for vivid, stable slow-motion playback. The faster the shutter speed, the darker the picture becomes. Use the shutter function under good lighting conditions.



SNOW: Compensates for subjects that may otherwise appear too dark when shooting in extremely bright surroundings such as in the snow.



SPOTLIGHT: Compensates for subjects that may otherwise appear too bright when shooting under extremely strong direct lighting such as spotlights.

NOTE:

“SPOTLIGHT” has the same effect as -3 with the exposure control. (☞ pg. 44)

☼ TWILIGHT: Makes evening scenes look more natural. White Balance (☞ pg. 48) is automatically set to “☼”, but can be changed to your desired setting. When Twilight is chosen, the camcorder automatically adjusts the focus from approx. 10 m (32 ft) to infinity. From less than 10 m (32 ft), adjust the focus manually.

- 1** Set the Recording Mode Switch to “HD”, “SD” or “DV”.
 - Some modes of Program AE cannot be used with the Switch set to “MEMORY”.
- 2** Set the Power Switch to “” while pressing down the Lock Button located on the switch.
- 3** Open the LCD monitor fully, or pull out the viewfinder fully.
- 4** Press **P.AE**. The PROGRAM AE screen appears.
- 5** Rotate the **MENU** Wheel to select the desired mode, and press it.
- 6** Press the **MENU** Wheel in to activate the selected effect.
 - The selected effect indicator appears.

To deactivate the selected effect...

Select “OFF” in step 5. Or, set the Power Switch to “”.

NOTE:

Program AE can be changed during recording or during Record-Standby.

IMPORTANT:

Some modes of Program AE cannot be used with certain Wipe/Fader effects. If an unusable mode is selected, the indicator of Wipe/Fader effects blinks or goes out.

Special Effects

Using the following 4 Effect Modes allows you to provide special effects for your shooting.

☐ SEPIA: Recorded scenes have a brownish tint like old photos. Using this effect with “DV WIDE” set to “SQUEEZE” (☞ pg. 38) provides “classic film” effect.

B/W MONOTONE: Like classic black and white films, your footage is shot in B/W. Using this effect with “DV WIDE” set to “SQUEEZE” (☞ pg. 38) provides “classic film” effect.

☼ CLASSIC FILM: Gives recorded scenes a strobe effect.

☐ STROBE: Your recording looks like a series of consecutive snapshots.

NOTES:

- When the Recording Mode Switch is set to “HD” or “MEMORY”, “MONOTONE” is only available.
- “SEPIA”, “CLASSIC FILM” and “STROBE” are not activated when the recording mode is set to “HD”.

- 1** Set the Recording Mode Switch to “SD” or “DV”.
 - Some modes of Special Effects cannot be used in “HD” or “MEMORY” mode.
- 2** Set the Power Switch to “” while pressing down the Lock Button located on the Switch.
- 3** Open the LCD monitor fully, or pull out the viewfinder fully.
- 4** Press **EFFECT**. The EFFECT screen appears.
- 5** Rotate the **MENU** Wheel to select the desired mode, and press it.
- 6** Press the **MENU** Wheel in to activate the selected effect.
 - The selected effect indicator appears.

To deactivate the selected effect...

Select “OFF” in step 5. Or, set the Power Switch to “”.

IMPORTANT:

Some modes of Special Effects cannot be used with certain Wipe/Fader effects. If an unusable mode is selected, the indicator of Wipe/Fader effects blinks.

To add thumbnail images during video playback

- 1 Perform steps 1 to 4 in “To find scenes on tape using thumbnail images (NAVIGATION Search)”.
- 2 Press ►|| to start video playback.
- 3 Press **NAVI STORE** at the desired point.
 - The “**NAV**” indicator appears briefly and the image of the point where **NAVI STORE** is pressed is stored in the memory card as a thumbnail image.
 - If you use the tape recorded in SD or HD mode, it will enter the playback pause mode. To play, press ►||.

To delete thumbnail images

- 1 Load a memory card. (☞ pg. 19)
- 2 Set the Playback Mode switch to “VIDEO”.
- 3 Set the Power Switch to “**PLAY**” while pressing down the Lock Button located on the switch.
- 4 Press the **MENU** Wheel in. The Menu Screen appears.
- 5 Rotate the **MENU** Wheel to select “**VIDEO**”, and press it. The VIDEO Menu appears.
- 6 Rotate the **MENU** Wheel to select “**NAVI.DEL.**”, and press it. The Sub Menu appears.
- 7 By rotating the **MENU** Wheel...

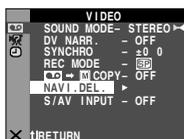

Select “**IMAGE SEL.**” to delete the currently displayed thumbnail image.

Select “**TAPE SEL.**” to delete all thumbnail images for the tape which contains the currently displayed image.

Select “**ALL**” to delete all thumbnail images stored in the memory card at once.

- 8 Press the **MENU** Wheel in. The NAVIGATION screen appears.
- 9 Rotate the **MENU** Wheel to select “**EXECUTE**”, and press it.



- Press ◀◀ to display the previous page. Press ▶▶ to display the next page.
- To cancel deletion, select “**RETURN**”.
- Thumbnail images cannot be deleted during video playback.

CAUTION:

Do not remove the memory card or perform any other operation (such as turning off the camcorder) during deletion. Also, be sure to use the provided AC Power Adapter/Charger, as the memory card may

be corrupted if the battery becomes exhausted during deletion. If the memory card becomes corrupted, initialize it.

NOTE:

Once images are deleted, they cannot be restored. Check images before deleting.

IMPORTANT:

- Be sure to always use the same tape and memory card together as they were during recording; otherwise, the camcorder cannot recognize Tape and Memory Card IDs to perform NAVIGATION function properly.
- Check if an appropriate tape and memory card are loaded when the following messages appear: “NO ID ON TAPE OR CARD”, “UNABLE TO USE NAVIGATION”, “THIS MEMORY CARD IS NOT COMPATIBLE”.
- If you change the memory card while shooting on one tape, two memory cards will share the tape’s thumbnail images. We recommend that you use one memory card for one tape.
- NAVIGATION Search does not work if the current position is at a blank portion on the tape. Also, do not leave a blank portion partway through the tape when shooting; otherwise, NAVIGATION function does not work properly.
- Before shooting newly over a recorded tape, be sure to delete all thumbnail images of the previous recording from the relevant memory card.
- If you copy thumbnail images from one memory card to another via a PC, NAVIGATION Search does not work with the copied memory card.

Dubbing To Or From A VCR

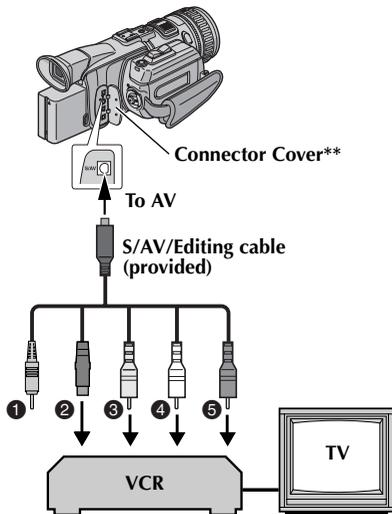

- ❶ Not required for connection.
- ❷ To S-VIDEO* IN or OUT
- ❸ Yellow to VIDEO IN or OUT
- ❹ White to AUDIO L IN or OUT
- ❺ Red to AUDIO R IN or OUT

* Connect when your TV/VCR has an S-VIDEO IN/OUT connector. In this case, it is not necessary to connect the yellow video cable.

** When connecting the cable, open the cover.

To use this camcorder as a player

- 1 Following the illustrations, connect the camcorder and the VCR. Also refer to page 26.
- 2 Set the camcorder's Playback Mode Switch to "VIDEO".
- 3 Set the camcorder's Power Switch to "PLAY" while pressing down the Lock Button located on the switch.
- 4 Turn on the VCR's power.
- 5 Insert the source cassette in the camcorder.
- 6 Insert the recording cassette in the VCR.
- 7 Engage the VCR's AUX and Record-Pause modes.
 - Refer to the instruction manual for the VCR.
- 8 Press ►|| on the camcorder to start playback of the source tape.
- 9 At the point you want to start dubbing, engage the VCR's Record mode.
- 10 To pause dubbing, engage the VCR's Record-Pause mode and press ►|| on the camcorder.
- 11 Repeat steps 8 – 10 for additional editing. Stop the VCR and camcorder.

NOTES:

- It is recommended to use the AC Power Adapter/Charger as the power supply instead of the battery pack. (☞ pg. 13)
- As the camcorder starts to play your footage, it will appear on your TV. This will confirm the connections and the AUX channel for dubbing purposes.
- Before you start dubbing, make sure that the indications do not appear on the connected TV. If they do, they are being recorded onto the new tape.

To choose whether or not the following displays appear on the connected TV...

- Date/time
Set "DATE/TIME" to "AUTO", "ON" or "OFF".
(☞ pg. 35, 42) Or, press **DISPLAY** on the remote control to turn on/off the date indication.
- Time code
Set "TIME CODE" to "OFF" or "ON".
(☞ pg. 35, 42)
- Indications other than date/time and time code
Set "ON SCREEN" to "OFF", "LCD" or "LCD/TV". (☞ pg. 35, 42)
- Playback images recorded in HD or SD mode with this camcorder will be converted to DV format (480i) image.

To use this camcorder as a recorder

- 1) Perform steps 1 to 3 in the left column.
- 2) Set "S/AV INPUT" to "AV IN". (☞ pg. 35, 41)
 - If your VCR has an S-VIDEO OUT connector, set "S/AV INPUT" to "S IN".
- 3) Set "REC MODE" to "SP" or "LP". (☞ pg. 35, 36)
- 4) Insert the recording cassette in this camcorder.
- 5) Press the Recording Start/Stop Button to engage the Record-Pause mode. The "**AV IN**" or "**S IN**" indication appears on the screen.
- 6) Press the Recording Start/Stop Button to start recording. The indication rotates.
- 7) Press the Recording Start/Stop Button again to stop recording. The indication stops rotating.

NOTES:

- After dubbing, set "S/AV INPUT" back to "OFF".
- Analog signals can be converted to digital signals with this procedure.
- It is also possible to dub from another camcorder.
- Depending on the tape source input, images may appear with horizontal jitter on the camcorder's LCD monitor and viewfinder during dubbing. This does not affect the actual recording.

Dubbing To Or From A Video Unit Equipped With An i.LINK Connector (Digital Dubbing)

Using an i.LINK cable (optional), it is possible to dub recorded scenes in DV format from the camcorder onto another video unit equipped with i.LINK connector. Since a digital signal is sent, there is little if any image or sound deterioration. Scenes recorded in SD or HD mode can be dubbed only to a D-VHS VCR with HS mode or another same model of this unit.

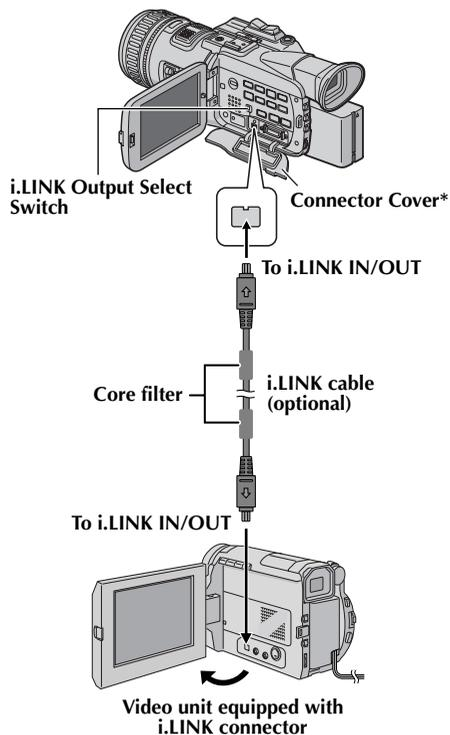

* When connecting the cable, open the cover.

NOTES:

- It is recommended to use the AC Power Adapter/Charger as the power supply instead of the battery pack. (☞ pg. 13)
- When using an i.LINK cable, be sure to use the optional JVC VC-VDV204U i.LINK cable.
- If the remote control is used when both the player and recorder are JVC video units, both units will perform the same operation. To prevent this from happening, press the buttons on both units.

To use this camcorder as a player

- 1 Make sure all units are turned off.
- 2 Connect this camcorder to a video unit equipped with an i.LINK input connector using an i.LINK cable as shown in the illustration.
- 3 Set this camcorder's Playback Mode Switch to "VIDEO".
- 4 Set this camcorder's Power Switch to "PLAY" while pressing down the Lock Button located on the switch.
- 5 Set "i.LINK OUT" to "SW". (☞ pg. 35, 39)
 - If, in future, the connected video unit automatically detects the DV and MPEG2 formats, set "i.LINK OUT" to "AUTO". In this case, proceed to step 7.
- 6 Set the i.LINK Output Select Switch on this camcorder to "DV" to output scenes recorded in DV mode, or "MPEG2" to output scenes recorded in HD or SD mode.
- 7 Turn on the video unit's power.
- 8 Insert the source cassette in this camcorder.
- 9 Insert the recording cassette in the video unit.
- 10 Press ►|| on this camcorder to start playback of the source cassette.
- 11 At the point you want to start dubbing, engage the video unit's Record mode.
- 12 To pause dubbing, engage the video unit's Record-Pause mode and press ►|| on this camcorder.
- 13 Repeat steps 10 – 12 for additional editing. Stop the video unit and camcorder.

NOTES:

- If a blank portion or disturbed image is played back on the player during dubbing, unusual images may be dubbed or the dubbing may stop.
- If a scene which has been paused during recording is dubbed to other devices, playback may stop at the point.
- If "Wipe Or Fader Effects" (☞ pg. 50), "Special Effects" (☞ pg. 51), "Playback Zoom" (☞ pg. 59) or "TIME CODE" (☞ pg. 39) is set, only the original playback image is output from the i.LINK IN/OUT connector.

To use this camcorder as a recorder

Dubbing from other devices in MPEG2 format is possible if the connected device is another same model of this unit. It is also possible to dub in MPEG2 format from a D-VHS VCR, if the source tape (D-VHS) has been originally dubbed from this digital HD video camera in MPEG2 format.

- However, if signals on the D-VHS tape are originally from an ATSC tuner etc., dubbing from a D-VHS VCR in MPEG2 format is not possible.

- 1 Perform step 1 to 4 of "To use this camcorder as a player" (☞ pg. 55).
- 2 Set "REC MODE" to "SP" or "LP". (☞ pg. 35, 36)
- 3 Turn on the video unit's power.
- 4 Insert the source cassette in the video unit.
- 5 Insert the recording cassette in this camcorder.
- 6 Press the Recording Start/Stop Button to engage the Record-Pause mode.
 - The "i.LINK IN" indication appears on the screen.
- 7 Press the Recording Start/Stop Button to start recording.
 - The  indication rotates.
- 8 Press the Recording Start/Stop Button again to engage the Record-Pause mode.
 - The  indication stops rotating.
- 9 Repeat steps 7 – 8 for additional editing. Stop the video unit and camcorder.

NOTES:

DV to DV dubbing

- If a blank portion or disturbed image is played back on the player during dubbing, unusual images may be dubbed or the dubbing may stop.

MPEG2 to MPEG2 dubbing

- **It is not possible to dub signals in MPEG2 format from devices other than D-VHS VCRs or another same model of this camcorder.**
- MPEG2 signals that are copy-guarded may not be recorded with this camcorder.
- When dubbing MPEG2 video to the camcorder, image may not appear on the LCD monitor or viewfinder. However, the recording is performed properly.

Notes on dubbing to a D-VHS VCR

Dubbing cannot be conducted properly when dubbing a tape which is recorded in both DV and HD (or SD) mode. In this case, perform the following procedure.

- 1 Disconnect the i.LINK cable.
- 2 Reset the i.LINK device number on the D-VHS VCR.
 - For the operation, refer to the instruction manual of the D-VHS VCR.
- 3 Set "i.LINK OUT" to "SW" on this camcorder. (☞ pg. 35, 39)
- 4 Set the i.LINK Output Select Switch on this camcorder to "DV" to output scenes recorded in DV mode, or "MPEG2" to output scenes recorded in HD or SD mode.
- 5 Connect the i.LINK cable again.
- 6 Start playback on this camcorder, and then start recording on the D-VHS VCR.

Dubbing Still Images Recorded On A Tape To A Memory Card

Still images can be dubbed from a tape to a memory card.

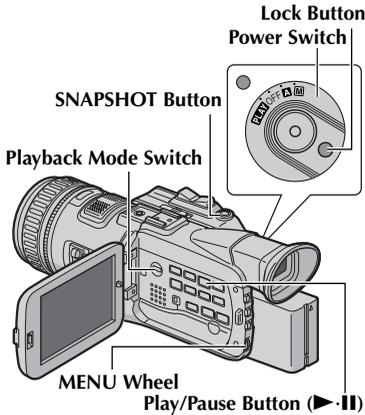

- 1** Load a cassette. (☞ pg. 18)
- 2** Load a memory card. (☞ pg. 19)
- 3** Set the Playback Mode Switch to "VIDEO".
- 4** Set the Power Switch to "PLAY" while pressing down the Lock Button located on the switch.
- 5** Set "CO ▶ M COPY" to "ON". (☞ pg. 35, 41)
- 6** Press ▶·|| to start playback.
- 7** At the point you want to dub, press ▶·|| again to engage Still Playback.
- 8** To dub the image, press **SNAPSHOT**.
 - The "▶ P" indication appears during dubbing.
 - The selected image is stored in the memory card.

NOTES:

- If **SNAPSHOT** is pressed in step **8** when a memory card is not loaded, the message "COPYING FAILED" is displayed.
- If an image recorded on the tape using "DV WIDE" (☞ pg. 38) is dubbed to a memory card, the WIDE mode identifying signal is not dubbed with it.
- To use Playback Special effects with a video image you wish to dub, perform up to step **8** using the remote control (provided). (☞ pg. 60)
- Images are dubbed in the following image sizes:
 - Scenes recorded in HD mode: 1280 x 720 pixels
 - Scenes recorded in SD mode: 848 x 480 pixels
 - Scenes recorded in DV mode: 640 x 480 pixels

The Full-Function Remote Control Unit can operate this camcorder from a distance as well as the basic operations (Playback, Stop, Pause, Fast-Forward and Rewind) of your VCR. It also makes additional playback functions possible. (☞ pg. 59)

Installing The Batteries

The remote control uses two "AAA (R03)" size batteries. Refer to "General Battery Precautions" (☞ pg. 78).

- 1 Remove the battery compartment cover while pushing up the tab as illustrated.
- 2 Insert two "AAA (R03)" size batteries in the correct direction.
- 3 Re-attach the battery compartment cover.

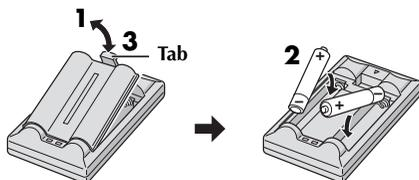

Insert the minus (-) end first.

Beam Effective Area (indoor use)

When using the remote control, be sure to point it at the remote sensor. The transmitted beam's approximate effective distance for indoor use is 5 m (16 ft).



Remote sensor

NOTE:

The transmitted beam may not be effective or may cause incorrect operation when the remote sensor is directly exposed to sunlight or powerful lighting.

Buttons And Functions

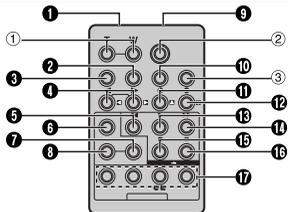

① Infrared beam transmitting window

Transmits the beam signal.

The following buttons are available only when the camcorder's Power Switch is set to "PLAY".

- ② **DISPLAY Button** (☞ pg. 27, 54, 63)
- ③ **SHIFT Button** (☞ pg. 59, 62)
- ④ **SLOW Rewind/Forward Buttons** (☞ pg. 59)
- ⑤ **Left/Right Buttons** (☞ pg. 59)
- ⑥ **REW Button**
 - Rewind/Reverse Shuttle Search on a tape (☞ pg. 25)
 - Displays previous file in a memory card (☞ pg. 29)
- ⑦ **FADE/WIPE Button** (☞ pg. 64)
- ⑧ **EFFECT ON/OFF Button** (☞ pg. 60)
- ⑨ **EFFECT Button** (☞ pg. 60)
- ⑩ **PAUSE IN Connector** (☞ pg. 63)
- ⑪ **MBR SET Button** (☞ pg. 62)
- ⑫ **Up Button** (☞ pg. 59)
- ⑬ **INSERT Button** (☞ pg. 61)
- ⑭ **Down Button** (☞ pg. 59)
- ⑮ **A. DUB Button** (☞ pg. 60)
- ⑯ **PLAY Button**
 - Starts Playback of a tape (☞ pg. 24)
 - Starts Auto Playback of images in a memory card (☞ pg. 29)
- ⑰ **FF Button**
 - Forward/Forward Shuttle Search on a tape (☞ pg. 25)
 - Displays next file in a memory card (☞ pg. 29)
- ⑱ **STOP Button**
 - Stops the tape (☞ pg. 24)
 - Stops Auto Playback (☞ pg. 29)
- ⑲ **PAUSE Button**
 - Pauses the tape (☞ pg. 59)
- ⑳ **R.A.EDIT Buttons** (☞ pg. 62 - 66)

The following buttons are available when the camcorder's Power Switch is set to "A" or "M".

- ① **Zoom (T/W) Buttons**
 - Zoom in/out (☞ pg. 22, 59)
 - Also available with the Power Switch set to "PLAY"
- ② **START/STOP Button**
 - Functions the same as the Recording Start/Stop Button on the camcorder.
- ③ **SNAPSHOT Button**
 - Functions the same as SNAPSHOT on the camcorder.

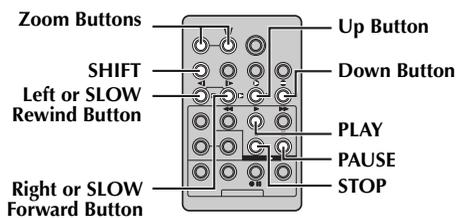

Playback Zoom (DV only)

Magnifies the recorded image up to 20X at any time during video playback and D.S.C. playback.

1) Press **PLAY** (▶) to start video playback. Or perform normal playback of images.



2) At the point you want to zoom in, press the Zoom Button (T).

- To zoom out, press the Zoom Button (W).



3) You can move the image on the screen around to find a particular portion of the picture. While holding down **SHIFT**, press ◀ (Left), ▶ (Right), ▲ (Up) and ▼ (Down).



- To end zoom, press and hold **W** until magnification returns to normal. Or, press **STOP** (■) and then press **PLAY** (▶) during video playback.

NOTES:

- Zoom can also be used during slow-motion and still playback.
- Due to digital image processing, the quality of the image may suffer.

Slow-Motion Playback (DV only)

Allows slow-speed search in either direction during video playback.

During normal video playback, press **SLOW** (◀| or |▶) more than approx. 2 seconds.

- After approx. 5 minutes (approx. 20 seconds with an 80-minute cassette) in Slow Rewind or approx. 5 minutes in Slow Forward, normal playback resumes.
- To pause Slow-Motion playback, press **PAUSE** (||).
- To stop Slow-Motion playback, press **PLAY** (▶).

NOTES:

- You can also engage Slow-Motion Playback from Still Playback by pressing **SLOW** (◀| or |▶) more than approx. 2 seconds.
- During Slow-Motion Playback, due to digital image processing, the picture may take on a mosaic effect.
- After **SLOW** (◀| or |▶) is pressed and held, the still image may be displayed for a few seconds, followed by a blue screen for a few seconds. This is not a malfunction.
- There may be a small margin between the slow-motion playback start point you chose and the actual start point for Slow-Motion Playback.
- During Slow-Motion Playback, there will be disturbances in video and the picture may seem unstable, especially with steady images. This is not a malfunction.

Frame-By-Frame Playback (DV only)

Allows frame-by-frame search during video playback.

During normal or still playback, press **SLOW** (|▶) repeatedly for forward or **SLOW** (◀|) repeatedly for reverse. Each time **SLOW** (◀| or |▶) is pressed, the frame is played back.

Playback Special Effects (DV only)

Allows you to add creative effects to the video playback image that was recorded in DV mode. The effects that can be used during playback are CLASSIC FILM, MONOTONE, SEPIA and STROBE. The effects work the same in playback as they did in recording. (☞ pg. 50)

CLASSIC FILM: Gives recorded scenes a strobe effect. Using this effect with "DV WIDE" set to "SQUEEZE" (☞ pg. 38) provides "classic film" effect.

B/W MONOTONE: Like classic black and white films, your footage is shot in B/W. Used together with the Cinema mode, it enhances the "classic film" effect. Using this effect with "DV WIDE" set to "SQUEEZE" (☞ pg. 38) provides "classic film" effect.

SEPIA: Recorded scenes have a brownish tint like old photos. Combine this with the Cinema mode for a classic look.

STROBE: Your recording looks like a series of consecutive snapshots.

- 1) To start playback, press **PLAY** (▶).
- 2) Press **EFFECT**. The PLAYBACK EFFECT Select Menu appears.
- 3) Press **EFFECT** repeatedly to move the highlight bar to the desired effect.
 - The selected function is activated and after 2 seconds the menu disappears.
 - To deactivate the selected effect, press **EFFECT ON/OFF**. To reactivate the selected effect press **EFFECT ON/OFF** again.
 - To change the selected effect, repeat from step 2 above.

Audio Dubbing (DV only)

The audio track of a tape recorded in DV format can be customized only when recorded in the 12-bit and SP modes. (☞ pg. 36)

Stereo Microphone

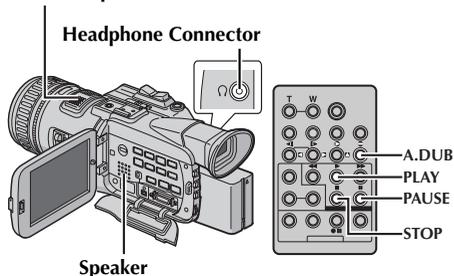

- 1 Play back the tape to locate the point where editing will start, then press **PAUSE** (⏸).
- 2 While holding **A. DUB** (⊖) on the remote control, press **PAUSE** (⏸). The "⏸" and "MIC" indicators appear.
- 3 Press **PLAY** (▶), then begin "narrating". Speak into the microphone.
 - To pause dubbing, press **PAUSE** (⏸).
- 4 To end Audio Dubbing, press **PAUSE** (⏸), then **STOP** (■).

To hear the sound during Audio Dubbing...

Connect optional headphones to the headphone connector or use the S/AV connector, and set "DV NARR." to the desired mode;

- "OFF" for the playback sound.
- "ON" for the dubbed sound.
- "MIX" for the playback and dubbed sound.

To hear the dubbed sound during playback...

Set "DV NARR." to "ON" or "MIX". (☞ pg. 35, 41)

NOTES:

- When editing onto a tape that was recorded at 12-bit, the old and new soundtracks are recorded separately.
- If you dub onto a blank space on the tape, the sound may be disrupted. Make sure you only edit recorded areas.
- If feedback or howling occurs during TV playback, move the camcorder's microphone away from the TV, or turn down the TV's volume.
- If you change from 12-bit to 16-bit in mid-recording and then use the tape for Audio Dubbing, it is not effective from the point where 16-bit recording began.
- During Audio Dubbing, when the tape moves to scenes recorded in the LP mode, scenes recorded in 16-bit audio or a blank portion, Audio Dubbing stops.
- To perform Audio Dubbing while watching on the television, make connections. (☞ pg. 26)
- To perform Audio Dubbing with a video unit connected to the camcorder's S/AV connector, first set "S/AV INPUT" to "AV IN" or "S IN" in VIDEO Menu. (☞ pg. 35, 41)
The "AUX" indication appears instead of "MIC".

indicator and the Time Code (min.:sec.) appear and the camcorder enters Insert-Pause mode.

- 4 Press **START/STOP** to begin editing.
 - Confirm the insert at the time code you checked in step 1.
 - To pause editing, press **START/STOP**. Press it again to resume editing.
- 5 To end Insert Editing, press **START/STOP**, then **STOP** (■).

NOTES:

- During Insert Editing, set the Recording Mode Switch to "DV".
- Special Effects (☞ pg. 51) can be used to spice up the scenes being edited during Insert Editing.
- During Insert Editing, the date and time information changes.
- If you perform Insert Editing onto a blank space on the tape, the audio and video may be disrupted. Make sure you only edit recorded areas.
- During Insert Editing, when the tape moves to scenes recorded in the LP mode or a blank portion, Insert Editing stops. (☞ pg. 76)
- If a memory card is loaded and "NAVIGATION" is set to other than "MANUAL", a NAVIGATION thumbnail image is stored in the memory card. (☞ pg. 52)

Insert Editing (DV only)

You can record a new scene into a previously recorded tape, replacing a section of the original recording with minimal picture distortion at the in and outpoints. The original audio remains unchanged.

A tape that was recorded in HD or SD mode cannot be used for Insert Editing.

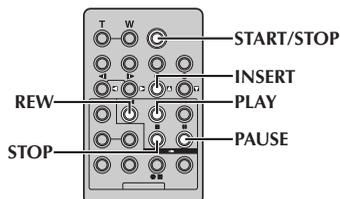
**NOTES:**

- Before performing the following steps, make sure that "TIME CODE" is set to "ON". (☞ pg. 35, 42)
- Insert Editing is not possible on a tape recorded in the LP mode or on a blank portion of a tape.
- To perform Insert Editing while watching in the television, make connections. (☞ pg. 26)

- 1 Play back the tape, locate the Edit-Out point and press **PAUSE** (■). Confirm the time code at this point. (☞ pg. 42)
- 2 Press **REW** (◀◀) until the Edit-In point is located, then press **PAUSE** (■).
- 3 Press and hold **INSERT** (○) on the remote control, then press **PAUSE** (■). The "■○"

Random Assemble Editing [R.A.Edit] (DV only)

Create edited videos easily using your camcorder as the source player. You can select up to 8 "cuts" for automatic editing, in any order you like. R.A.Edit is more easily performed when the MBR (Multi-Brand Remote) is set to operate with your brand of VCR (see "VCR CODE LIST"), but can also be performed by operating the VCR manually.

Before operation, make sure the batteries are installed in the remote control. (☞ pg. 58)

NOTE:

Random Assemble Editing is not possible with a tape recorded in HD or SD mode.

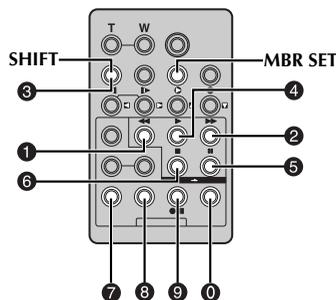

Set Remote/VCR Code

- 1 Turn off the power to the VCR and point the remote towards the VCR's infrared sensor. Then, referring to the VCR CODE LIST, press and hold **MBR SET**, and enter the brand code. The code is automatically set once you release **MBR SET**, and the VCR's power comes on.
- 2 Make sure the VCR's power is on. Then, while holding **SHIFT**, press the button on the remote for the desired function. The functions the remote can control are **PLAY, STOP, PAUSE, FF, REW** and **VCR REC STBY** (you do not need to press **SHIFT** for this one).

You are now ready to try Random Assemble Editing.

IMPORTANT:

Although the MBR is compatible with JVC VCRs and those of many other makers, it may not work with yours or may offer limited functions.

NOTES:

- If the VCR's power does not come on in step 1, try another code from the VCR CODE LIST.
- Some brands of VCR do not come on automatically. In this case, turn the power on manually and try step 2.
- If the remote control is not able to control the VCR, use the controls on the VCR.

- When the remote control's batteries run out, the VCR brand you have set will be erased. In that case, replace the old battery with a new one to reset the VCR brand.

VCR CODE LIST

VCR BRAND NAME	CODE	VCR BRAND NAME	CODE
DAEWOO	1 8	PANASONIC	1 3 1 7 1 1 1 4 1 8
GE	1 1 9 2 9 0 9 4	RCA	9 2 9 4 6 6 6 3 9 0
HITACHI	6 6 6 3	SAMSUNG	9 4
JVC A B C	9 1 9 6 9 3	SANYO	3 6 3 5
LG/GOLDSTAR	1 1	SHARP	1 5 1 0
MAGNAVOX	9 5 1 1 7 1 7 6	SONY	6 5 6 0 3 9 3 1
MITSUBISHI	6 7 6 8	TOSHIBA	6 9 6 1
NEC	3 7 3 8	ZENITH	1 6
PHILIPS	1 9 1 5 1 1 9 4 9 1 9 6 1 2 3 3 7 2		

Make Connections

Also refer to page 26.

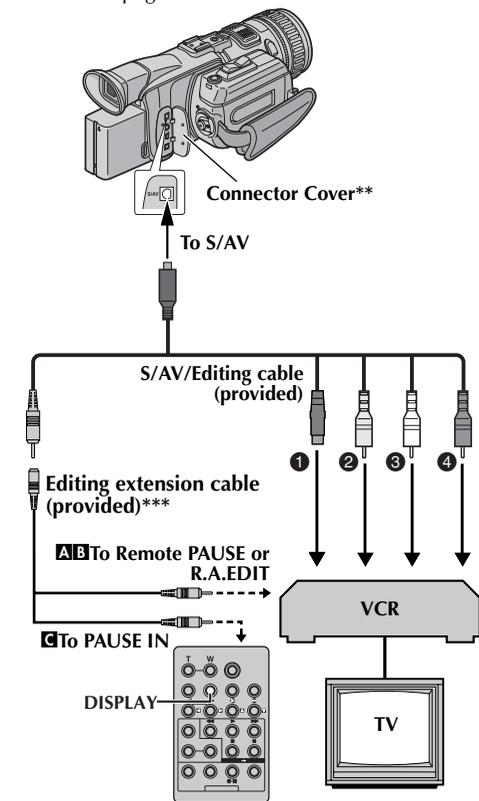

- ❶ Black to S-VIDEO IN*
- ❷ Yellow to VIDEO IN
- ❸ White to AUDIO L IN
- ❹ Red to AUDIO R IN

* Connect when your TV/VCR has an S-VIDEO IN connector. In this case, it is not necessary to connect the yellow video cable.

** When connecting the cable, open the cover.

*** If necessary, use this cable for connections.

1 **A JVC VCR equipped with a Remote PAUSE connector...**

...Connect the editing cable to the Remote PAUSE connector.

2 **A JVC VCR not equipped with a Remote PAUSE connector but equipped with an R.A.EDIT connector...**

...Connect the editing cable to the R.A.EDIT connector.

3 **A VCR other than above...**

...Connect the editing cable to the remote control's PAUSE IN connector.

2 Insert a recorded tape into the camcorder.

3 Set the Playback Mode Switch to "VIDEO".

4 Set the Power Switch to "PLAY" while pressing down the Lock Button located on the switch.

5 Turn the VCR power on, insert a recordable tape and engage the AUX mode.

- Refer to the VCR's instructions.

NOTES:

- Before *Random Assemble Editing*, make sure the indications do not appear on the TV monitor. If they do, they will be recorded onto the new tape. **To choose whether or not the following displays appear on the connected TV...**

• Date/time

Set "DATE/TIME" to "AUTO", "ON" or "OFF".
(☞ pg. 35, 42) Or, press **DISPLAY** on the remote control to turn on/off the date indication.

• Time code

Set "TIME CODE" to "OFF" or "ON".
(☞ pg. 35, 42)

- Indications other than date/time and time code
Set "ON SCREEN" to "OFF", "LCD" or "LCD/TV". (☞ pg. 35, 42)

Select Scenes

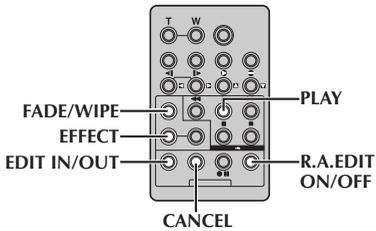

6 Press **PLAY** (▶) and then press **R.A.EDIT ON/OFF** on the remote control. The Random Assemble Editing Menu appears.

7 If using a Wipe/Fader at the beginning of the scene, press **FADE/WIPE** on the remote control.

- Cycle through the effects by pressing repeatedly, and stop when the one you want is displayed.
- You cannot use a Picture Wipe/Dissolve at the beginning of Program 1.

8 At the beginning of the scene, press **EDIT IN/OUT** on the remote control. The Edit-In position appears in the Random Assemble Editing Menu.

9 At the end of the scene, press **EDIT IN/OUT**. The Edit-Out position appears in the Random Assemble Editing Menu.

10 If using a Wipe/Fader at the end of the scene, press **FADE/WIPE**.

- Cycle through the effects by pressing repeatedly, and stop when the one you want is displayed.
- If you select a Wipe/Fader effect for an Edit-Out point, the effect is automatically applied to the following Edit-In point.
- You cannot use a Picture Wipe/Dissolve at the end of the last scene.
- When you use Fader/Wipe effects, that time is included in the total time (this does not apply to Picture Wipe/Dissolve).

11 If using Playback Special Effects, press **EFFECT**. (☞ pg. 60)

12 Repeat steps **8** through **11** to register additional scenes.

- To change previously registered points, press **CANCEL** on the remote control. The registered points disappear, one at a time, from the most recently registered point.
- If you are not using Wipe/Fader or Program AE with special effects, repeat steps **8** and **9** only.

- If the search time for an in-point exceeds 5 minutes, the recording deck's Record-Standby mode will be cancelled and editing will not take place.
- If there are blank portions before or after the Edit-In and Edit-Out points, a blue screen may be included in the edited version.
- Since time codes register time only as accurately as seconds, the time code total time may not match the total program time exactly.
- Turning off the camcorder's power erases all registered Edit-In and Edit-Out points.
- If you select Sepia or Monotone mode from Special Effects, you cannot use the Dissolve or Black & White Fader. In this case the Dissolve or Black & White indicator begins blinking. Once the next Edit-In point is registered, the effect is turned off. To combine these effects, use Sepia or Monotone during recording, then use the Dissolve or Black & White Fader during Random Assemble Editing.
- It is not possible to use Wipe/Fader effects, Program AE and Special Effects during Random Assemble Editing using i.LINK cable.

Selected parameter

	IN	OUT	MODE
1	---	---	---
2	---	---	---
3	---	---	---
4	---	---	---
5	---	---	---
6	---	---	---
7	---	---	---
8	---	---	---
TIME CODE			---
TOTAL			00:00

NOTES:

- When choosing a scene, set Edit-In and Edit-Out points so that there is a relatively large difference between them.

Picture Wipe And Dissolve Menu

(available only for Random Assemble Editing)

You can use not only the wipe/fader effects on page 50 but also the picture wipe and dissolve effects below.

DISSOLVE: The new scene gradually appears as the old one gradually disappears.

WIPE – CORNER: The new scene wipes in over the previous one from the upper right corner to the lower left corner.

WIPE – WINDOW: The next scene gradually wipes in from the center of the screen toward the corners, covering the previous scene.

WIPE – SLIDE: The next scene gradually wipes in over the previous one from right to left.

WIPE – DOOR: The previous scene wipes out from the center to the right and left, like a door being pushed open to reveal the next scene.

WIPE – SCROLL: The new scene wipes in over the last one from the bottom of the screen to the top.

WIPE – SHUTTER: The new scene wipes in over the previous one from the center toward the top and bottom of the screen.

Automatic Editing To VCR

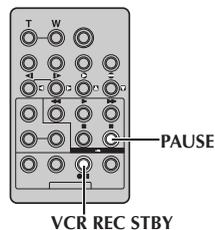

- 13** Rewind the tape in the camcorder to the beginning of the scene you want to edit and press **PAUSE (II)**.
- 14** Press **VCR REC STBY (●II)**, or manually engage the VCR's Record-Pause mode.
- 15** Press the Recording Start/Stop Button on the camcorder. Editing proceeds as programmed, right through to the end of the last registered scene.
 - When dubbing is complete, the camcorder enters the Pause mode, and the VCR enters its Record-Pause mode.
 - If you do not register an Edit-Out point, the tape will be dubbed all the way to the end automatically.
 - If you operate the camcorder during automatic editing, the VCR will enter its Record-Pause mode and automatic editing will stop.
- 16** Engage the Stop modes for the camcorder and the VCR.
To make the R.A.Edit counter display disappear, press **R.A.EDIT ON/OFF** on the remote control.

NOTES:

- Pressing **R.A.EDIT ON/OFF** on the remote control clears all settings registered during Random Assemble Editing.
- When the editing cable is connected to the remote control's **PAUSE IN** connector during dubbing, make sure the remote control is pointed at the VCR's sensor, and the path between the two is unobstructed.
- Random Assemble Editing may not function properly when using a tape including several duplicated time codes. (☞ pg. 23)

For More Accurate Editing

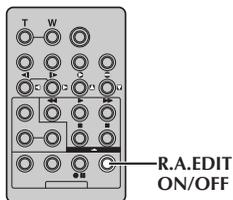

Some VCRs make the transition from Record-Pause to Record mode faster than others. Even if you begin editing for the camcorder and the VCR at exactly the same time, you may lose scenes you wanted, or find that you have recorded scenes you did not want. For a cleanly edited tape, confirm and adjust the timing of the camcorder against your VCR.

Diagnosing VCR/Camcorder Timing

- 1 Play back the tape in the camcorder, then point the remote control at the camcorder's remote sensor and press **R.A.EDIT ON/OFF**. Random Assemble Editing Menu appears.

Program 1

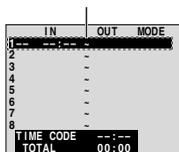

Random Assemble Editing Menu

- 2 Perform Random Assemble Editing on Program 1 only. In order to check VCR and camcorder timing, select the beginning of a scene transition as your Edit-In point.
- 3 Play back the dubbed scene.
 - If any images from the scene prior to the transition you chose for your Edit-In point were recorded, that means your VCR moves too quickly from Record-Pause to Record mode.
 - If the scene you tried to dub starts in progress, the VCR is slow to start recording.

Adjustment Of VCR/Camcorder Timing

- 4 Press **R.A.EDIT ON/OFF** to make the Random Assemble Editing menu disappear, then press the **MENU** Wheel in. The Menu Screen appears.
- 5 Rotate the **MENU** Wheel to select "VIDEO", and press it. The VIDEO Menu appears.
- 6 Rotate the **MENU** Wheel to select "SYNCHRO", and press it. The value for "SYNCHRO" is highlighted.
- 7 Based on the diagnostics performed, you can now advance the VCR's record timing by rotating the **MENU** Wheel towards "+". You can also delay the VCR's record timing by rotating the **MENU** Wheel towards "-". The adjustment range is from -1.3 to +1.3 seconds, in 0.1-second increments. Press the **MENU** Wheel in to finish the setting.
- 8 Rotate the **MENU** Wheel to select "RETURN", and press it twice. Now perform Random Assemble Editing beginning with step 6 on page 64.

NOTES:

- Before performing actual Random Assemble Editing, do a few Random Assemble Editing trial runs to check whether the value you have input is appropriate or not, and make adjustments accordingly.
- Depending on the recorder, there may be situations where the timing difference cannot be fully corrected.

Connection To A Personal Computer

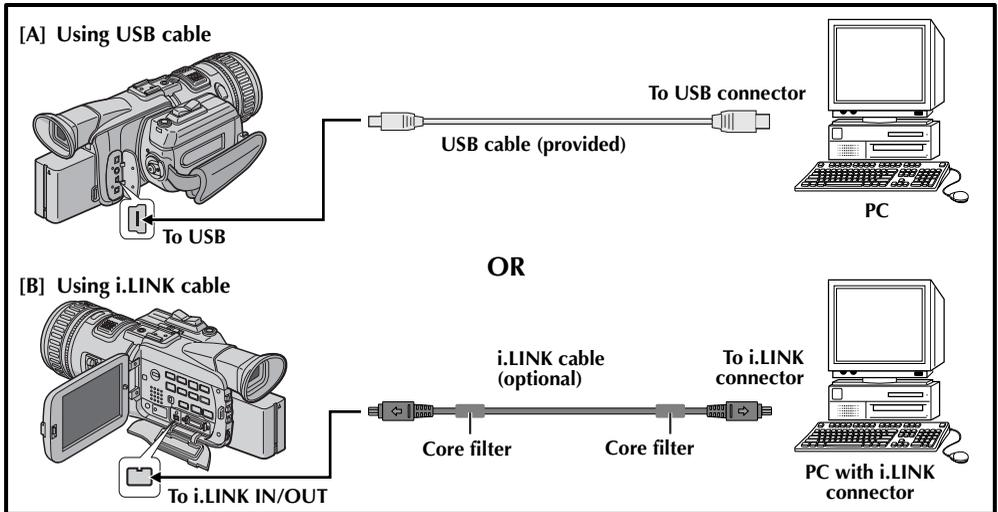

[A] Using USB cable

It is possible to do the following things:

- Transfer still images stored on a memory card to a PC.
- Use this camcorder as a WebCam. (☞ pg. 68)

[B] Using i.LINK cable

It is also possible to transfer still/moving images to a PC with an i.LINK connector by using the provided software, software equipped with the PC or commercially available software.

NOTES:

- Refer to "SOFTWARE INSTALLATION AND USB CONNECTION GUIDE" for the installation of the bundled software and drivers.
- The software operation manual is provided as PDF file on the CD-ROM.
- It is recommended to use the AC Power Adapter/Charger as the power supply instead of the battery pack. (☞ pg. 13)
- Never connect the USB cable and the i.LINK cable simultaneously to the camcorder. Connect only the cable you wish to use to the camcorder.

- When using an i.LINK cable, be sure to use the optional JVC VC-VDV206U or VC-VDV204U i.LINK cable depending on the type of i.LINK connector (4 or 6 pins) on the PC.
- If the PC connected to the camcorder via the USB cable is not powered, the camcorder does not enter the USB mode.
- The date/time information cannot be captured into the PC.
- Refer to the instruction manuals of the PC and Software.
- The still images can also be transferred to a PC with an i.LINK connector-equipped capture board.
- The system may not work properly depending on the PC or capture board you are using.

"USB MODE" and/or "ACCESSING FILES" appears on the LCD monitor while the PC is accessing data in the camcorder or the camcorder is transferring a file to the PC.

NEVER disconnect the USB cable while "ACCESSING FILES" is displayed on the LCD monitor since this can result in product damage.

Using The Camcorder As A WebCam

This camcorder can be used as a WebCam via USB connection.

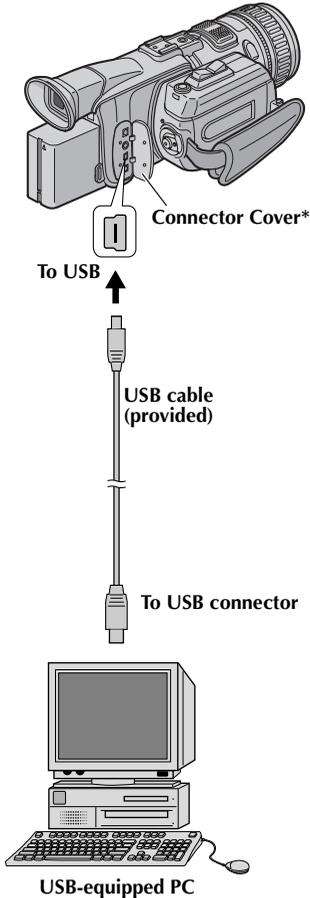

- 1** Make sure all necessary software (provided) are installed in your PC.
- 2** Set the Recording Mode Switch to "MEMORY".
- 3** Set the Power Switch to "A" or "M" while pressing down the Lock Button located on the switch.
- 4** Connect the camcorder to your PC using the USB cable.
 - "CAM" appears on the screen.
 - If the PC is not powered on, the camcorder does not enter the Web Camera mode.
- 5** When finished, turn off the PC first, then the camcorder. Disconnect the USB cable from the camcorder and PC.

NOTES:

- **It is recommended to use the AC Power Adapter/Charger as the power supply instead of the battery pack.** (☞ pg. 13)
- You can also use the camcorder for video conference over the Internet by using Microsoft Windows® Messenger®. For details, refer to the instruction manual of the provided software.
- In the Web Camera mode, the following buttons cannot be operated: **SNAPSHOT, INDEX, NAVI, NAVI STORE**, the Recording Start/Stop Button.

Refer to the instruction manuals of the PC and provided Software.

* When connecting the cable, open the cover.

ITEMS	NOTES
<p>⇨ Power (☞ pg. 12)</p>	<ul style="list-style-type: none"> ● Perform charging where the temperature is between 10°C and 35°C (50°F and 95°F). 20°C to 25°C (68°F to 77°F) is the ideal temperature range for charging. If the environment is too cold, charging may be incomplete. ● Charging times are for a fully discharged battery pack. ● Charging time varies according to the ambient temperature and the status of the battery pack. ● To avoid interference with reception, do not use the AC Power Adapter/Charger near a radio. ● Since the AC Power Adapter/Charger processes electricity internally, it becomes warm during use. Be sure to use it only in well-ventilated areas.
<p>⇨ VIDEO RECORDING (☞ pg. 20)</p>	<ul style="list-style-type: none"> ● When you use the LCD monitor outdoors in direct sunlight, the LCD monitor may be difficult to see. If this happens, use the viewfinder instead. ● The cassette holder cannot be opened unless a power supply is attached. ● There may be a delay after you open the cassette holder cover until the cassette holder opens. Do not use force. ● Once the cassette holder is closed, it recedes automatically. Wait until it recedes completely before closing the cassette holder cover. ● When the Recording Start/Stop button is pressed, it may take a few seconds before actual recording starts. The “▶” indicator starts rotating when the camcorder actually starts recording. ● The time required to calculate and display the remaining tape length, and the accuracy of the calculation, may vary according to the type of tape used. ● “TAPE END” appears when the tape reaches its end, and the power goes off automatically if left in this condition for 5 minutes. “TAPE END” also appears when a cassette at its end is loaded. ● During recording, sound is not heard from the speaker. To hear the sound, connect optional headphones to the headphone connector. Adjust the sound volume by rotating the MENU Wheel. (☞ pg. 24) ● During Interface Shooting, the “Tape Running” indicator and warning indications (☞ pg. 75 – 77) are the only ones that are shown; they appear reversed in the display as they would when viewing a mirror, but are not reversed in the recording. ● The tape remaining indicator does not appear during interface shooting. However, when the remaining time reaches 2 minutes, the indicator appears showing the remaining time: ▶■■■— (blinking) ▶■■■— (blinking) ▶■■■ (blinking)

If, after following the steps in the chart below, the problem still exists, please consult your nearest JVC dealer.

The camcorder is a microcomputer-controlled device. External noise and interference (from a TV, a radio, etc.) might prevent it from functioning properly. In such cases, first disconnect its power supply unit (battery pack, AC Power Adapter/Charger, etc.) and wait a few minutes; and then re-connect it and proceed as usual from the beginning.

Power

SYMPTOM	POSSIBLE CAUSES	CORRECTIVE ACTION
1. No power is supplied.	1. <ul style="list-style-type: none"> • The power is not connected properly. • The battery is dead. • The LCD monitor is not open fully or the viewfinder is not pulled out when recording. 	1. <ul style="list-style-type: none"> • Connect the AC Power Adapter/Charger securely. (☞ pg. 13) • Replace the dead battery with a fully charged one. (☞ pg. 12, 13) • Open the LCD monitor fully or pull out the viewfinder.

Video and D.S.C. Recording

SYMPTOM	POSSIBLE CAUSES	CORRECTIVE ACTION
2. Recording cannot be performed.	2. <ul style="list-style-type: none"> • The Power Switch is set to "PLAY" or "OFF". — For Video Recording — • The tape's erase protection tab is set to "SAVE". • The Recording Mode Switch is set to "MEMORY". • "TAPE END" appears. • The cassette holder cover is open. — For D.S.C. Recording — • The Recording Mode Switch is not set to "MEMORY". 	2. <ul style="list-style-type: none"> • Set the Power Switch to "A" or "M". (☞ pg. 20, 28) — For Video Recording — • Set the tape's erase protection tab to "REC". (☞ pg. 18) • Set the Recording Mode Switch to "VIDEO". • Replace with new cassette. (☞ pg. 18) • Close the cassette holder cover. — For D.S.C. Recording — • Set the Recording Mode Switch to "MEMORY".
3. When shooting a subject illuminated by bright light, vertical lines appear.	3. <ul style="list-style-type: none"> • This is a result of exceedingly high contrast, and is not a malfunction. 	3. —
4. When the screen is under direct sunlight during shooting, the screen becomes red or black for an instant.	4. <ul style="list-style-type: none"> • This is not a malfunction. 	4. —
5. During recording, the date/time does not appear.	5. <ul style="list-style-type: none"> • "DATE/TIME" is set to "OFF". 	5. <ul style="list-style-type: none"> • Set "DATE/TIME" to "ON". (☞ pg. 35, 39)
6. During recording, sound cannot be heard.	6. <ul style="list-style-type: none"> • The optional headphones are not connected to the headphones connector. 	6. <ul style="list-style-type: none"> • Connect the optional headphones to the headphone connector. (☞ pg. 85)

7. The LCD monitor or viewfinder indications blink.	7. • Certain Wipe/Fader effects, certain modes of Program AE, "OIS" and other functions that cannot be used together are selected at the same time.	7. • Re-read the sections covering Wipe/Fader effects, Program AE and "OIS". (☞ pg. 37, 50)
8. Digital Zoom does not work.	8. • 10X optical zoom is selected. • The Recording Mode Switch is set to "MEMORY".	8. • Set "ZOOM" to "40X" or "200X". (☞ pg. 36) • Set the Recording Mode Switch to an appropriate position except "MEMORY".

Video and D.S.C. Playback

SYMPTOM	POSSIBLE CAUSES	CORRECTIVE ACTION
9. Play, Rewind and Fast-Forward functions do not work.	9. • The Power Switch is set to "A" or "M". • The Playback Mode Switch is set to "MEMORY".	9. • Set the Power Switch to "PLAY". (☞ pg. 24) • Set the Playback Mode Switch to "VIDEO".
10. The tape is moving, but there is no picture.	10. • Your TV has AV input terminals, but is not set to its VIDEO mode. • The cassette holder cover is open.	10. • Set the TV to the mode or channel appropriate for video playback. (☞ pg. 26) • Close the cassette holder cover. (☞ pg. 18)
11. Blocks of noise appear during playback, or there is no playback picture and the screen becomes blue.	11. —	11. • Clean the video heads with an optional cleaning cassette.
12. A memory card cannot be played back.	12. • The Power Switch is set to "A" or "M". • The Playback Mode Switch is set to "VIDEO".	12. • Set the Power Switch to "PLAY". (☞ pg. 29) • Set the Playback Mode Switch to "MEMORY".
13. The image on the 4:3 TV is elongated vertically (squeeze).	13. • This occurs during recording in HD or SD mode when a tape (its erase protection tab is set to "REC") is loaded. • The component video cable and S/AV/Editing cable are connected simultaneously.	13. • This is not a malfunction. • Disconnect either of two cables.
14. The screen of the LCD monitor or viewfinder is blackened or blocks of noise appear on its right side when the Power Switch is set to "PLAY" for dubbing (but ► is not pressed).	14. • The S/AV/Editing cable is connected and "S/AV INPUT" (☞ pg. 41) is set to "A/V IN" or "S IN".	14. • This is not a malfunction. After dubbing, set "S/AV INPUT" back to "OFF".

Advanced features

SYMPTOM	POSSIBLE CAUSES	CORRECTIVE ACTION
15. The focus does not adjust automatically.	15. <ul style="list-style-type: none"> • Focus is set to the Manual mode. • The recording was done in a dark place, or the contrast was low. • The lens is dirty or covered with condensation. 	15. <ul style="list-style-type: none"> • Set Focus to the Auto mode. (☞ pg. 46) • Clean the lens and check the focus again. (☞ pg. 81)
16. In the 5-Second mode, recording ends before 5 seconds have elapsed.	16. <ul style="list-style-type: none"> • The 5-Second mode is set to "Anim." in MANUAL Menu. 	16. <ul style="list-style-type: none"> • Set "5S" to "5S" in MANUAL Menu. (☞ pg. 35, 37)
17. Snapshot mode cannot be used.	17. <ul style="list-style-type: none"> • The Squeeze mode (SQUEEZE) is selected. 	17. <ul style="list-style-type: none"> • Disengage the Squeeze (SQUEEZE) mode. (☞ pg. 35, 38)
18. The color of Snapshot looks strange.	18. <ul style="list-style-type: none"> • The light source or the subject does not include white. Or there are various different light sources behind the subject. • The Sepia (SEPIA) or Monotone (MONOTONE) mode is activated. 	18. <ul style="list-style-type: none"> • Find a white subject and compose your shot so that it also appears in the frame. (☞ pg. 28, 44) • Disengage the Sepia (SEPIA) and Monotone (MONOTONE). (☞ pg. 35, 51)
19. The image taken using Snapshot is too dark.	19. <ul style="list-style-type: none"> • Shooting was performed under backlit conditions. 	19. <ul style="list-style-type: none"> • Press BACK LIGHT. (☞ pg. 45)
20. The image taken using Snapshot is too bright.	20. <ul style="list-style-type: none"> • The subject is too bright. 	20. <ul style="list-style-type: none"> • Press PAE and set "PROGRAM AE" to "SPOTLIGHT". (☞ pg. 50)
21. White Balance cannot be activated.	21. <ul style="list-style-type: none"> • The Sepia (SEPIA) or Monotone (MONOTONE) mode is activated. 	21. <ul style="list-style-type: none"> • Disengage the Sepia (SEPIA) or Monotone (MONOTONE) mode before setting White Balance. (☞ pg. 51)
22. Wipe/Fader effects do not work.	22. <ul style="list-style-type: none"> • The Power Switch is set to "A". 	22. <ul style="list-style-type: none"> • Set the Power Switch to "M". (☞ pg. 16)
23. The Black & White Fader does not work.	23. <ul style="list-style-type: none"> • The Sepia (SEPIA) or Monotone (MONOTONE) mode is activated. 	23. <ul style="list-style-type: none"> • Disengage the Sepia (SEPIA) and Monotone (MONOTONE). (☞ pg. 35, 51)
24. Program AE does not work.	24. <ul style="list-style-type: none"> • The Power Switch is set to "A". 	24. <ul style="list-style-type: none"> • Set the Power Switch to "M". (☞ pg. 16)
25. Cannot record signals from a device which is connected to the i.LINK IN/OUT connector.	25. <ul style="list-style-type: none"> • The connected device is not compatible with this camcorder. 	25. <ul style="list-style-type: none"> • Dubbing from other devices in MPEG2 format is possible if the connected device is another same model of this unit. It is also possible to dub in MPEG2 format from a D-VHS VCR, if the source tape (D-VHS) has been originally dubbed from this digital HD video camera in MPEG2 format.

Other problems

SYMPTOM	POSSIBLE CAUSES	CORRECTIVE ACTION
26. The CHARGE indicator on the AC Power Adapter/Charger does not light.	26. • The temperature of the battery is extremely high/low. • Charging is difficult in places subject to extremely high/low temperatures.	26. • To protect the battery, it is recommended to charge it in places with a temperature of 10°C to 35°C (50°F to 95°F). (☞ pg. 78)
27. "SET DATE/TIME!" appears.	27. • The built-in clock's rechargeable lithium battery is discharged. • The previously set date/time is erased.	27. • Connect the camcorder to an AC outlet using the AC Power Adapter/Charger for over 24 hours to charge the clock's lithium battery. (☞ pg. 17)
28. There is no picture.	28. • The camcorder is not getting power, or some other malfunction exists.	28. • Turn the camcorder's power off and on again. (☞ pg. 16)
29. Some functions are not available using the MENU Wheel.	29. • The Power Switch is set to "A".	29. • Set the Power Switch to "M". (☞ pg. 16)
30. Files stored in the memory card cannot be deleted.	30. • Files stored in the memory card are protected.	30. • Remove protection from the files stored in the memory card and delete them. (☞ pg. 31 – 32)
31. When the image is printed from the printer, a black bar appears at the bottom of the screen.	31. • This is not a malfunction.	31. • By recording with "OIS" activated (☞ pg. 35, 37) this can be avoided.
32. When the camcorder is connected via the i.LINK connector, the camcorder does not operate.	32. • The i.LINK cable was plugged/unplugged with power turned on.	32. • Turn the camcorder's power off and on again, then operate it.
33. The rear of the LCD monitor is hot.	33. • The light used to illuminate the LCD monitor causes it to become hot.	33. • Close the LCD monitor to turn it off or set the Power Switch to "OFF", and let the unit cool down.
34. Images on the LCD monitor appear dark or whitish.	34. • In places subject to low temperature, images become dark due to the characteristics of the LCD monitor. When this happens, the displayed colors differ from those that are actually recorded. This is not a defect of the camcorder. • When the LCD monitor's fluorescent light reaches the end of its service life, images on the LCD monitor become dark. Consult your nearest JVC dealer.	34. • Adjust the brightness and angle of the LCD monitor. (☞ pg. 14, 15)

<p>35. Colored bright spots appear all over the LCD monitor or the viewfinder.</p>	<p>35. • The LCD monitor and the viewfinder are made with high-precision technology. However, black spots or bright spots of light (red, green or blue) may appear constantly on the LCD monitor or the viewfinder. These spots are not recorded on the tape. This is not due to any defect of the unit. (Effective dots: more than 99.99%)</p>	<p>35. —</p>
<p>36. The indicators and the image color on the LCD monitor are not clear.</p>	<p>36. • This may occur when the surface or the edge of the LCD monitor is pressed.</p>	<p>36. —</p>
<p>37. The cassette will not load properly.</p>	<p>37. • The battery's charge is low.</p>	<p>37. • Install a fully charged battery. (☞ pg. 12, 13)</p>
<p>38. The memory card cannot be removed from the camcorder.</p>	<p>38. —</p>	<p>38. • Push in the memory card a few more times. (☞ pg. 19)</p>
<p>39. Picture does not appear on the LCD monitor.</p>	<p>39. • The viewfinder is pulled out and "PRIORITY" is set to "FINDER". • The LCD monitor's brightness setting is too dark.</p>	<p>39. • Push the viewfinder back in or set "PRIORITY" to "LCD" or "BOTH". (☞ pg. 14, 35, 38) • Adjust the brightness of the LCD monitor. (☞ pg. 15) • If the monitor is tilted upward 180 degrees, open the monitor fully. (☞ pg. 14)</p>
<p>40. Images on the LCD monitor are jittery.</p>	<p>40. • The speaker volume is too great.</p>	<p>40. • Turn the speaker volume down. (☞ pg. 24)</p>
<p>41. The LCD monitor, the viewfinder and the lens have become dirty (ex. fingerprints).</p>	<p>41. —</p>	<p>41. • Wipe them gently with soft cloth. Wiping strongly can cause damage. (☞ pg. 81) To clean the viewfinder, please consult your nearest JVC dealer.</p>
<p>42. Time code does not appear.</p>	<p>42. • "TIME CODE" is set to "OFF".</p>	<p>42. • Set "TIME CODE" to "ON". (☞ pg. 35, 39, 42)</p>
<p>43. An error indication (E01, E02 or E06) appears.</p>	<p>43. • A malfunction of some kind has occurred. In this case the camcorder's functions become unusable.</p>	<p>43. • ☞ pg. 77.</p>
<p>44. An error indication (E03 or E04) appears.</p>	<p>44. • A malfunction of some kind has occurred. In this case the camcorder's functions become unusable.</p>	<p>44. • ☞ pg. 77.</p>
<p>45. The remote control does not work.</p>	<p>45. • "REMOTE" is set to "OFF". • The remote control does not point at the remote sensor. • The remote control batteries are exhausted.</p>	<p>45. • Set "REMOTE" to "ON". (☞ pg. 35, 38) • Point at the remote sensor. (☞ pg. 58) • Replace the batteries with fresh ones. (☞ pg. 58)</p>

Warning Indications

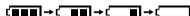
Indications	Meaning
	Displays the battery remaining power. Remaining power level: high  Remaining power level: exhausted  As the battery power comes close to nil, the battery indicator blinks. When the battery power is exhausted, power turns off automatically.
	Appears when no tape is loaded. (☞ pg. 18)
CHECK TAPE'S ERASE PROTECTION TAB	Appears when the erase protection tab is set to "SAVE" while the Power Switch is set to "A" or "M" and the Recording Mode Switch is set to any mode except "MEMORY". (☞ pg. 16)
 HEAD CLEANING REQUIRED USE CLEANING CASSETTE	Appears if dirt is detected on the heads during recording. Use an optional cleaning cassette.
 CONDENSATION OPERATION PAUSED PLEASE WAIT	Appears if condensation occurs. When this indication is displayed, wait more than 1 hour until condensation disappears.
TAPE!	Appears if a tape is not loaded when the Recording Start/Stop Button or SNAPSHOT Button is pressed while the Power Switch is set to "A" or "M" and the Recording Mode Switch is set to any mode except "MEMORY".
TAPE END	Appears when the tape ends during recording or playback. (☞ pg. 69)
SET DATE/TIME!	<ul style="list-style-type: none"> ● Appears when the date/time is not set. (☞ pg. 17) ● Appears when the built-in clock (lithium) battery is discharged and the previously set date/time is erased. (☞ pg. 17)
LENS CAP	Appears for 5 seconds after power is turned on if the lens cap is attached.
CAN NOT PLAY BACK THIS TAPE	Appears when you attempt to play back a tape that is not compatible with this camcorder.
CAN NOT CHANGE RECORDING MODE RECORDING IS STOPPED	Appears when you attempt to change the recording mode during recording. (☞ pg. 21)
INVALID DATA! CAN NOT RECORD COPY PROTECTED CAN NOT RECORD	Appears when you attempt to record signals which are copygurdred or not compatible with this camcorder.

Warning Indications

Indications	Meaning
CAN NOT DISPLAY ON LCD MONITOR AND VIEWFINDER IN THIS MODE	Appears when dubbing a scene recorded in HD mode through the component video connectors. (☞ pg. 55)
i.LINK CONNECTION ERROR! CHECK CABLE CONNECTION	Appears when an i.LINK cable is connected but not detected. Disconnect the cable once and connect it again, or disconnect other connected cables. (☞ pg. 55)
TO CHANGE i.LINK OUTPUT SETTING, DISCONNECT i.LINK CABLE, FIRST	Appears when you attempt to change the i.LINK output mode while an i.LINK cable is connected. (☞ pg. 55)
INVALID DATA! CAN NOT INPUT COPY PROTECTED CAN NOT INPUT CAN NOT DECODE VIDEO OR AUDIO	Appears when you attempt to dub signals which are copygurdred or not compatible with this camcorder through an i.LINK cable.
A. DUB ERROR!	Appears if Audio Dubbing is attempted on a blank portion of a tape. (☞ pg. 60)
A. DUB ERROR! <MPEG2 RECORDED> <CANNOT DUB ON A LP RECORDED TAPE> <CANNOT DUB ON A 16bit RECORDING> <CHECK TAPE'S ERASE PROTECTION TAB>	<ul style="list-style-type: none"> ● Appears if Audio Dubbing is attempted on a tape recorded in SD or HD mode. (☞ pg. 60) ● Appears if Audio Dubbing is attempted on a tape recorded in the LP mode. (☞ pg. 60) ● Appears if Audio Dubbing is attempted on a tape recorded in 16-bit audio. (☞ pg. 60) ● Appears if A. DUB (●) on the remote control is pressed when the erase protection tab is set to "SAVE". (☞ pg. 60)
INSERT ERROR!	Appears if Insert Editing is attempted on a blank portion of a tape. (☞ pg. 61)
INSERT ERROR! <MPEG2 RECORDED> <CANNOT EDIT ON A LP RECORDED TAPE> <CHECK TAPE'S ERASE PROTECTION TAB> <CHANGE REC. MODE TO DV>	<ul style="list-style-type: none"> ● Appears if Insert Editing is attempted on a tape recorded in SD or HD mode. (☞ pg. 61) ● Appears if Insert Editing is attempted on a tape recorded in the LP mode. (☞ pg. 61) ● Appears if INSERT (●) on the remote control is pressed when the erase protection tab is set to "SAVE". (☞ pg. 61)
CAN NOT R.A.E. THIS TAPE	Appears if Random Assemble Editing is attempted on a tape recorded in SD or HD mode. (☞ pg. 62)

Warning Indications

Indications	Meaning
MEMORY IS FULL	Appears when the memory card's memory is full and shooting is not possible.
COPYING FAILED	<ul style="list-style-type: none"> ● Appears if dubbing of copyguarded signals is attempted while this camcorder is being used as a recorder. ● Appears in the following cases when dubbing still images from a tape to a memory card: <ul style="list-style-type: none"> – when no memory card is loaded. – when the memory card's memory is full. – when the memory card is not formatted. – when a write-protected SD Memory Card is loaded. (☞ pg. 57)
MEMORY CARD!	Appears if there is no memory card loaded when you attempt to record on a memory card or access data on a memory card.
PLEASE FORMAT	Appears when there is a problem with a memory card and its memory is corrupt, or it has not been initialized. Initialize the memory card. (☞ pg. 34)
NO IMAGES STORED	Appears if there are no image files stored in the memory card when you attempt memory card playback.
CARD ERROR!	Appears when the camcorder does not recognize the loaded memory card. Remove the memory card once and insert it again. Repeat these procedures until no indication appears. If the indication still appears, the memory card is corrupted.
UNSUPPORTED FILE!	Appears when playing back a file that is not compatible with DCF or a file with a size that is not compatible with this camcorder.
CHECK CARD'S WRITE PROTECTION SWITCH	<ul style="list-style-type: none"> ● Appears when you attempt to shoot digital still images when the write protection tab on the SD Memory Card is set to the "LOCK" position. ● Appears when you attempt MEMORY SELECT menu operation with a write-protected SD Memory Card loaded.
E01, E02 or E06 UNIT IN SAFEGUARD MODE REMOVE AND REATTACH BATTERY	The error indications (E01, E02 or E06) show what type of malfunction has occurred. When an error indication appears, the camcorder turns off automatically. Remove the power supply (battery, etc.) and wait a few minutes for the indication to clear. When it does, you can resume using the camcorder. If the indication remains, consult your nearest JVC dealer.
E03 or E04 UNIT IN SAFEGUARD MODE EJECT AND REINSERT TAPE	The error indications (E03 or E04) show what type of malfunction has occurred. When an error indication appears, the camcorder turns off automatically. Eject the cassette once and re-insert it, then check if the indication clears. When it does, you can resume using the camcorder. If the indication remains, consult your nearest JVC dealer.

When using the AC Power Adapter/Charger in areas other than the USA

- The provided AC Power Adapter/Charger features automatic voltage selection in the AC range from 110 V to 240 V.

USING HOUSEHOLD AC PLUG ADAPTER

In case of connecting the unit's power cord to an AC wall outlet other than American National Standard C73 series type use an AC plug adapter, called a "Siemens Plug", as shown.

For this AC plug adapter, consult your nearest JVC dealer.

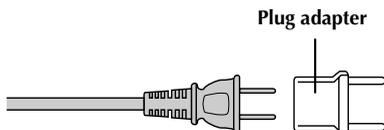

General Battery Precautions

If the remote control is not functioning even if it is being operated correctly, the batteries are exhausted. Replace them with fresh ones.

Use only the following batteries: AAA (R03) size x 2

Please make note of the following rules for battery use. When misused, the batteries can leak or explode.

1. When replacing batteries, refer to page 58.
2. **Do not** use any different size of batteries from those specified.
3. Be sure to install batteries in the correct direction.
4. **Do not** use rechargeable batteries.
5. **Do not** expose the batteries to excessive heat as they can leak or explode.
6. **Do not** dispose of the batteries in a fire.
7. Remove the batteries from the unit if it is to be stored for an extended period to avoid battery leakage which can cause malfunctions.
8. **Do not** recharge the provided batteries.

Battery Packs

The supplied battery pack is a lithium-ion battery. Before using the provided battery pack or an optional battery pack, be sure to read the following cautions:

1. To avoid hazards...

- ... **do not** burn.
- ... **do not** short-circuit the terminals. When transporting, make sure the provided battery cap is attached to the battery. If the battery cap is misplaced, carry the battery in a plastic bag.
- ... **do not** modify or disassemble.

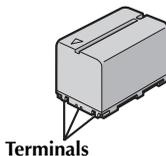

- ... **do not** expose the battery to temperatures exceeding 60°C (140°F), as this may cause the battery to overheat, explode or catch fire.
- ... use only specified chargers.

2. To prevent damage and prolong service life...

- ... do not subject to unnecessary shock.
- ... charge in an environment where temperatures are within the tolerances shown in the chart below. This is a chemical reaction type battery — cooler temperatures impede chemical reaction, while warmer temperatures can prevent complete charging.
- ... store in a cool, dry place. Extended exposure to high temperatures will increase natural discharge and shorten service life.
- ... fully charge and then fully discharge the battery every 6 months when storing the battery pack over a long period time.
- ... remove from charger or powered unit when not in use, as some machines use current even when switched off.

NOTES:

- *It is normal for the battery pack to be warm after charging, or after use.*
- Temperature Range Specifications**
 Charging.....10°C to 35°C (50°F to 95°F)
 Operation.....0°C to 40°C (32°F to 104°F)
 Storage.....-20°C to 50°C (-4°F to 122°F)
- *Recharging time is based on room temperature of 20°C (68°F).*
- *The lower the temperature, the longer recharging takes.*

Cassettes

To properly use and store your cassettes, be sure to read the following cautions:

1. During use...

- ... make sure the cassette bears the Mini DV mark.
- ... be aware that recording onto prerecorded tapes automatically erases the previously recorded video and audio signals.
- ... make sure the cassette is positioned properly when inserting.
- ... do not load and unload the cassette repeatedly without allowing the tape to run at all. This slackens the tape and can result in damage.
- ... do not open the front tape cover. This exposes the tape to fingerprints and dust.

2. Store cassettes...

- ... away from heaters or other heat sources.
- ... out of direct sunlight.
- ... where they won't be subject to unnecessary shock or vibration.
- ... where they won't be exposed to strong magnetic fields (such as those generated by motors, transformers or magnets).
- ... vertically, in their original cases.

Memory Cards

To properly use and store your memory cards, be sure to read the following cautions:

1. During use...

- ... make sure the memory card bears the SD or MultiMediaCard mark.
- ... make sure the memory card is positioned properly when inserting.

2. While the memory card is being accessed (during recording, playback, deletion, initialization, etc.)...

- ... never unload the memory card and never turn off the camcorder.

3. Store memory cards...

- ... away from heaters or other heat sources.
- ... out of direct sunlight.
- ... where they won't be subject to unnecessary shock or vibration.
- ... where they won't be exposed to strong magnetic fields (such as those generated by motors, transformers or magnets).

LCD Monitor

1. To prevent damage to the LCD monitor, DO NOT...

- ... push it strongly or apply any shocks.
- ... place the camcorder with the LCD monitor on the bottom.

2. To prolong service life...

- ... avoid rubbing it with coarse cloth.

3. Be aware of the following phenomena for LCD monitor use.

These are not malfunctions:

- While using the camcorder, the surface around the LCD monitor and/or the back of the LCD monitor may heat up.
- If you leave power on for a long time, the surface around the LCD monitor becomes hot.

Main Unit

1. For safety, DO NOT...

- ... open the camcorder's chassis.
- ... disassemble or modify the unit.
- ... short-circuit the terminals of the battery pack. Keep it away from metallic objects when not in use.
- ... allow inflammables, water or metallic objects to enter the unit.
- ... remove the battery pack or disconnect the power supply while the power is on.
- ... leave the battery pack attached when the camcorder is not in use.

2. Avoid using the unit...

- ... in places subject to excessive humidity or dust.
- ... in places subject to soot or steam such as near a cooking stove.

- ... in places subject to excessive shock or vibration.
- ... near a television set.
- ... near appliances generating strong magnetic or electric fields (speakers, broadcasting antennas, etc.).
- ... in places subject to extremely high (over 40°C or 104°F) or extremely low (under 0°C or 32°F) temperatures.

3. DO NOT leave the unit...

- ... in places of over 50°C (122°F).
- ... in places where humidity is extremely low (below 35%) or extremely high (above 80%).
- ... in direct sunlight.
- ... in a closed car in summer.
- ... near a heater.

4. To protect the unit, DO NOT...

- ... allow it to become wet.
- ... drop the unit or strike it against hard objects.
- ... subject it to shock or excessive vibration during transportation.
- ... keep the lens directed at extremely bright objects for long periods.
- ... expose the lens and viewfinder's lens to direct sunlight.
- ... carry it by holding the LCD monitor or the viewfinder.
- ... swing it excessively when using the hand strap or the grip.
- ... swing the soft camera case excessively when the camcorder is inside it.

5. Dirty heads can cause the following problems:

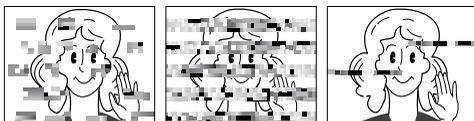

- No picture during playback.
 - Blocks of noise appear during playback.
 - During recording or playback, the Head Clog Warning indicator "⊗" appears.
 - Recording cannot be performed properly.
- In such cases, use the provided cleaning cassette. Insert it and play back. If the cassette is used more than once consecutively, damage to the video heads may result. After the camcorder plays back for about 20 seconds, it stops automatically. Also refer to the cleaning cassette's instructions.
- If, after using the cleaning cassette, the problems still exist, consult your nearest JVC dealer.
- Mechanical moving parts used to move the video heads and video tape tend to become dirty and worn out over time. In order to maintain a clear picture at all times, periodic check-ups are recommended after using the unit for about 1,000 hours. For periodic check-ups please consult your nearest JVC dealer.

How To Handle A CD-ROM

- Take care not to soil or scratch the mirror surface (opposite to the printed surface). Do not write anything or put a sticker on either the front or back surface. If the CD-ROM gets dirty, gently wipe it with a soft cloth outward from the center hole using a circular motion.
- Do not use conventional disc cleaners or cleaning spray.
- Do not bend the CD-ROM or touch its mirror surface.
- Do not store your CD-ROM in a dusty, hot or humid environment. Keep it away from direct sunlight.

About moisture condensation...

- You have observed that pouring a cold liquid into a glass will cause drops of water to form on the glass' outer surface. This same phenomenon occurs on the head drum of a camcorder when it is moved from a cool place to a warm place, after heating a cold room, under extremely humid conditions or in a place directly subjected to the cool air from an air conditioner.
- Moisture on the head drum can cause severe damage to the video tape, and can lead to internal damage to the camcorder itself.

Serious malfunctioning

If malfunctioning occurs, stop using the unit immediately and consult your local JVC dealer.

The camcorder is a microcomputer-controlled device. External noise and interference (from a TV, a radio, etc.) might prevent it from functioning properly. In such cases, first disconnect its power supply unit (battery pack, AC Power Adapter/Charger, etc.) and wait a few minutes and then reconnect it and proceed as usual from the beginning.

Declaration of Conformity

Model Number : GR-HD1U
 Trade Name : JVC
 Responsible party : JVC AMERICAS CORP.
 Address : 1700 Valley Road Wayne,
 N. J. 07470
 Telephone Number : 973-317-5000
 This device complies with Part 15 of FCC Rules. Operation is subject to the following two conditions: (1) This device may not cause harmful interference, and (2) this device must accept any interference received, including interference that may cause undesired operation.

Change or modifications not approved by the party responsible for compliance could void the user's authority to operate the equipment. This equipment has been tested and found to comply with the limits for a Class B digital device, pursuant to Part 15 of the FCC Rules. These limits are designed to provide reasonable protection against harmful interference in a residential installation. This equipment generates, uses, and can radiate radio frequency energy and, if not installed and used in accordance with the instructions, may cause harmful interference to radio communications. However, there is no guarantee that interference will not occur in a particular installation. If this equipment does cause harmful interference to radio or television reception, which can be determined by turning the equipment off and on, the user is encouraged to try to correct the interference by one or more of the following measures:

- Reorient or relocate the receiving antenna.
- Increase the separation between the equipment and receiver.
- Connect the equipment into an outlet on a circuit different from that to which the receiver is connected.
- Consult the dealer or an experienced radio/ TV technician for help.

This Class B digital apparatus complies with Canadian ICES-003.

Cet appareil numérique de la classe B est conforme à la norme NMB-003 du Canada.

After Use

- 1 Turn off the camcorder.
- 2 Loosen the grip strap.
- 3 Slide and hold **OPEN/EJECT** in the direction of the arrow, then pull the cassette holder cover open until it locks. The cassette holder opens automatically. Remove the cassette.
- 4 Press "PUSH HERE" to close the cassette holder.
 - Once the cassette holder is closed, it recedes automatically. Wait until it recedes completely before closing the cassette holder cover.
- 5 Slide **BATT.RELEASE** ① and remove the battery pack ② ③.

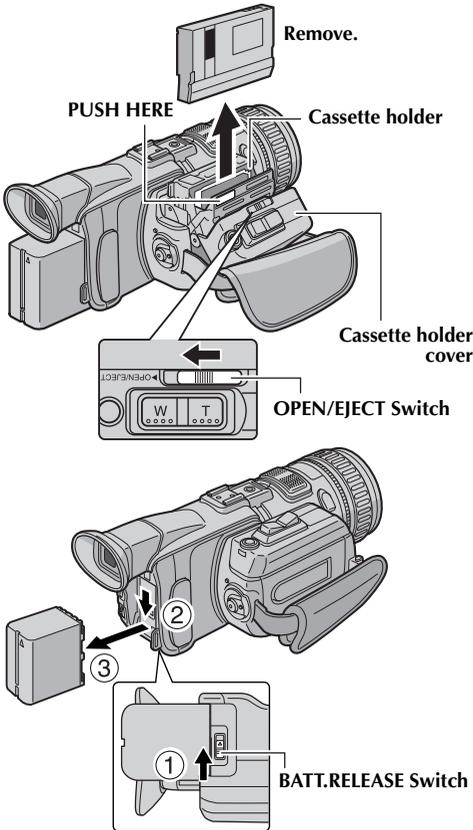

Cleaning The Camcorder

- 1 To clean the exterior, wipe gently with a soft cloth. Put the cloth in diluted mild soap and wring it well to wipe off heavy dirt. Then wipe again with a dry cloth.
- 2 Press **PUSH OPEN** and open the LCD monitor. Wipe gently with a soft cloth. Be careful not to damage the monitor. Close the LCD monitor.
- 3 To clean the lens, blow it with a blower brush, then wipe gently with lens cleaning paper.
- 4 To clean the viewfinder, raise the viewfinder to the vertical position.
- 5 Open the viewfinder cleaning hatch in the direction of the arrow ①. Insert a lens blower or soft cloth into the gap at the bottom of the viewfinder and clean the interior of the viewfinder with it ②.
- 6 Close the hatch. Tilt the viewfinder back to the horizontal position and push it back in.

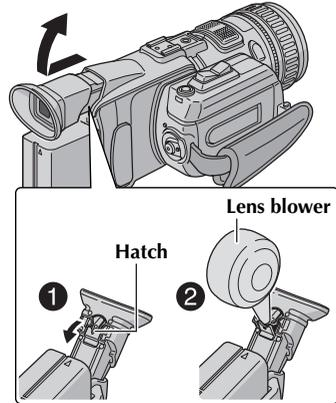

NOTES:

- Avoid using strong cleaning agents such as benzine or alcohol.
- Cleaning should be done only after the battery pack has been removed or other power units have been disconnected.
- Mould may form if the lens is left dirty.
- When using a cleaner or chemically treated cloth refer to the cautions of each product.

Camcorder

For General

Power supply	: DC 6.3 V (Using AC Power Adapter/Charger) DC 7.2 V (Using battery pack)
Power consumption	
LCD monitor off, viewfinder on	: Approx. 6.8 W (DV)/8.0 W (HD, SD)
LCD monitor on, viewfinder off	: Approx. 8.5 W (DV)/9.7 W (HD, SD)
Dimensions (W x H x D)	: 114.5 mm x 99 mm x 271.5 mm (4-9/16" x 3-15/16" x 10-3/4") (with the LCD monitor closed and the viewfinder pushed back in)
Weight	: Approx. 1270 g (2.8 lbs) (without cassette, memory card and battery) Approx. 1490 g (3.3 lbs) (incl. cassette, memory card and battery)
Operating temperature	: 0°C to 40°C (32°F to 104°F)
Operating humidity	: 35% to 80%
Storage temperature	: -20°C to 50°C (-4°F to 122°F)
Pickup	: 1/3" CCD
Lens	: F 1.8, f = 5.2 mm to 52 mm, 10:1 power zoom lens
Filter diameter	: ø52 mm
LCD monitor	: 3.5" diagonally measured, LCD panel/TFT active matrix system
Viewfinder	: Electronic viewfinder with 0.44" color LCD
Speaker	: Monaural

For Digital Video Camera

Signal format	: NTSC standard
Cassette	: Mini DV cassette
Tape speed	: SP: 18.8 mm/s LP: 12.5 mm/s
Maximum recording time (using 80 min. cassette)	: SP: 80 min. LP: 120 min.

For Digital Still Camera

Storage media	: SD Memory Card/MultiMediaCard
Compression system	: JPEG (compatible)
File size	: 2 modes (1280 x 960 pixels/640 x 480 pixels)
Picture quality	: 2 modes (FINE/STANDARD)
Approximate number of storable images	:  pg. 40

For Connectors**S/AV**

S-Video input	: Y: 0.8 V to 1.2 V (p-p), 75 Ω , analog C: 0.2 V to 0.4 V (p-p), 75 Ω , analog
S-Video output	: Y: 1.0 V (p-p), 75 Ω , analog C: 0.29 V (p-p), 75 Ω , analog
Video input	: Y: 0.8 V to 1.2 V (p-p), 75 Ω , analog
Video output	: Y: 1.0 V (p-p), 75 Ω , analog
Audio input	: 300 mV (rms), 50 k Ω , analog, stereo
Audio output	: 300 mV (rms), 1 k Ω , analog, stereo
Headphone output	: Stereo
Microphone input	: Stereo
i.LINK	
Input/output	: 4-pin, IEEE 1394 compliant
USB	: 5-pin
Y/Pb/Pr output	: Y: 1.0 V (p-p), 75 Ω , analog Pb: 0.7 V (p-p), 75 Ω , analog Pr: 0.7 V (p-p), 75 Ω , analog

AC Power Adapter/Charger**For General****Power requirement**

U.S.A. and Canada	: AC 120 V \sim , 60 Hz
Other countries	: AC 110 V to 240 V \sim , 50 Hz/60 Hz

Power consumption : 23W

Output

Charge	: DC 7.2 V  , 1.2 A
VTR	: DC 6.3 V  , 1.8 A

Specifications shown are for SP mode unless otherwise indicated. E & O.E. Design and specifications subject to change without notice.

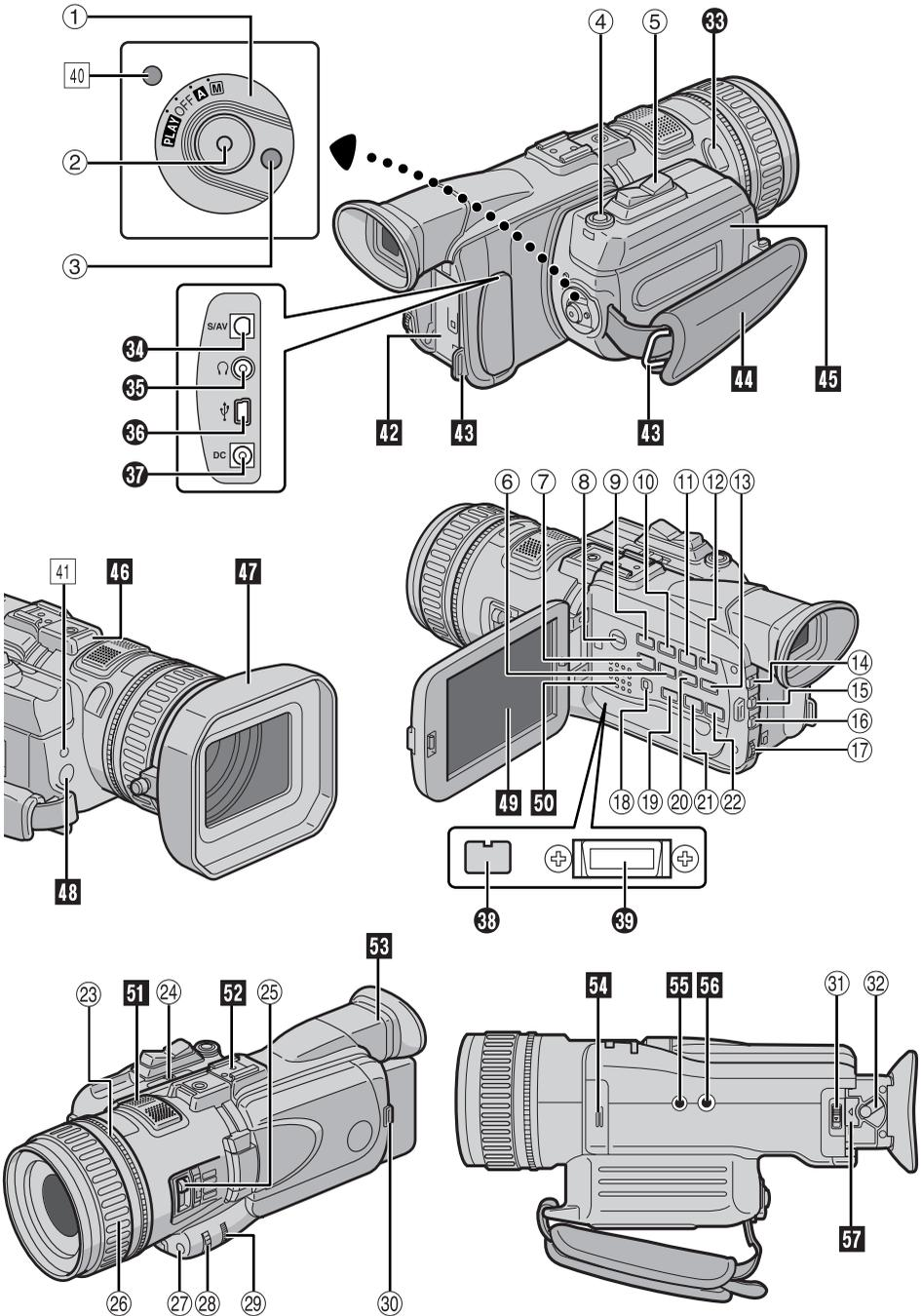

Controls

- ① Power Switch [A, M, PLAY, OFF] (☞ pg. 16)
- ② Recording Start/Stop Button (☞ pg. 20)
- ③ Lock Button (☞ pg. 16)
- ④ Snapshot Button [SNAPSHOT] (☞ pg. 28, 44)
- ⑤ Power Zoom Switch [T/W] (☞ pg. 22)
- ⑥ Information Button [INFO] (☞ pg. 30)
- ⑦ Index Button [INDEX] (☞ pg. 30)
- ⑧ Playback Mode Switch [VIDEO/MEMORY] (☞ pg. 16)
- ⑨ Stop Button [■] (☞ pg. 24)
- ⑩ Rewind Button [◀◀] (☞ pg. 24)
- ⑪ Play/Pause Button [▶•II] (☞ pg. 24)
- ⑫ Fast-Forward Button [▶▶] (☞ pg. 24)
- ⑬ Thumbnail Storing Button [NAVI STORE] (☞ pg. 53)
- ⑭ Program AE Button [P.AE] (☞ pg. 50)
- ⑮ Shutter Speed/Iris Control Button [S/A] (☞ pg. 46)
- ⑯ Manual White Balance button [WHITE BALANCE] (☞ pg. 48)
- ⑰ •Menu Wheel [MENU] (☞ pg. 35)
- Speaker/Headphone Volume Control [VOLUME +, -] (☞ pg. 24)
- ⑱ i.LINK Output Select Switch [DV/MPEG2] (☞ pg. 55)
- ⑲ Blank Search Button [BLANK SEARCH] (☞ pg. 25)
- ⑳ Navigation Button [NAVI] (☞ pg. 52)
- ㉑ Wipe or Fader Effect Button [FADE/WIPE] (☞ pg. 50)
- ㉒ Special Effects Button [EFFECT] (☞ pg. 51)
- ㉓ Manual Zoom Ring (☞ pg. 47)
- ㉔ Cassette Open/Eject Switch [OPEN/EJECT] (☞ pg. 18)
- ㉕ Recording Mode Switch [MEMORY/HD/SD/DV] (☞ pg. 16)
- ㉖ Manual Focus Ring (☞ pg. 47)
- ㉗ Backlight Compensation Button [BACK LIGHT] (☞ pg. 45)
- ㉘ Manual Focus Button [FOCUS] (☞ pg. 47)
- ㉙ Exposure Adjustment Wheel [EXPOSURE] (☞ pg. 44)
- ㉚ Monitor Opening Button [PUSH OPEN] (☞ pg. 20)
- ㉛ Battery Release Switch [BATTERY] (☞ pg. 12)
- ㉜ Dioptr Adjustment Control (☞ pg. 15)

Connectors

The connectors are located beneath the covers.

- ㉝ Microphone connector [MIC] (☞ pg. 10)
Open the connector cover, and attach the optional microphone.
- ㉞ S/AV connector (☞ pg. 26, 54, 63)
- ㉟ Headphone Connector [∩] (☞ pg. 10, 60)
No sound is output from the speaker when headphones are connected to this connector.

- ㊱ USB (Universal Serial Bus) Connector (☞ pg. 67)
- ㊲ DC Input Connector [DC] (☞ pg. 12, 13)
- ㊳ Digital Video Connector [i.LINK IN/OUT] (i.Link*) (☞ pg. 55, 56, 67)
* i.Link refers to the IEEE1394-1995 industry specification and extensions thereof. The logo is used for products compliant with the i.Link standard.
- ㊴ Component Video Connectors [Y/Pb/Pr] (☞ pg. 26)

Indicators

- ㊵ Power Lamp (☞ pg. 16, 20)
- ㊶ Tally Lamp (☞ pg. 20, 38)

Other Parts

- ㊷ Battery Pack Mount (☞ pg. 12)
- ㊸ Shoulder Strap Eyelet (☞ pg. 10)
- ㊹ Grip Strap (☞ pg. 14)
- ㊺ •Cassette Holder Cover •Rotating Grip (☞ pg. 18)
- ㊻ Camera Sensor
Be careful not to cover this area, a sensor necessary for shooting is built-in here.
- ㊼ Lens Hood (☞ pg. 8)
- ㊽ Remote Sensor (☞ pg. 58)
- ㊾ LCD Monitor (☞ pg. 14, 22)
- ㊿ Speaker (☞ pg. 24)
- ㊽ Stereo Microphone (☞ pg. 60)
- ㊽ Shoe

- Attach the provided Handle, optional Stereo Microphone or Video Light. Make sure to turn off the power of the camcorder and the video light or microphone before attaching and removing them.
- ㊽ Viewfinder (☞ pg. 15)
- ㊽ Card Cover [MEMORY CARD] (☞ pg. 19)
- ㊽ Stud Hole (☞ pg. 14)
- ㊽ Tripod Mounting Socket (☞ pg. 14)
- ㊽ Viewfinder Cleaning Hatch (☞ pg. 81)

LCD Monitor/Viewfinder Indications

During Video Recording Only

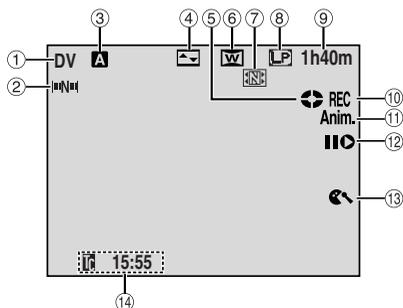

- ① **Recording Mode Indicator** (☞ pg. 21)
- ② **Navigation Indicator** (☞ pg. 52)
(Appears when "NAVIGATION" is set to other than "MANUAL".)
- ③ **Operation Mode Indicator** (☞ pg. 16)
- ④ **Selected Wipe/Fader Effect Indicator** (☞ pg. 50)
- ⑤ **Tape Running Indicator** (☞ pg. 20)
(Rotates while tape is running.)
- ⑥ **Selected Wide Mode Indicator** (☞ pg. 38)
- ⑦ **Thumbnail Storing Indicator** (☞ pg. 52)
(Appears while the captured image is being stored as a thumbnail image in the memory card.)
- ⑧ **Recording Speed Mode (SP/LP)** (☞ pg. 36)
- ⑨ **Tape Remaining Time** (☞ pg. 22)
- ⑩ **•REC:** (Appears during recording.) (☞ pg. 20)
•PAUSE: (Appears during Record-Standby mode.) (☞ pg. 20)
- ⑪ **5S/Anim.:** Displays the 5-Second Recording mode or Animation recording mode. (☞ pg. 37)
- ⑫ **Insert Editing/Insert Editing Pause Mode** (☞ pg. 61)
- ⑬ **Wind Cut Indicator** (☞ pg. 38)
- ⑭ **Time Code** (☞ pg. 39, 42)

During D.S.C. Recording Only

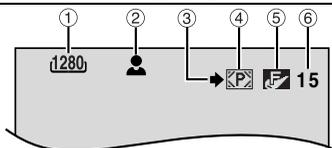

- ① **Image Size: 1280 (1280 x 960) or 640 (640 x 480)** (☞ pg. 40)
- ② **Focus Icon** (☞ pg. 28)
(Blinks while the focus is being adjusted and stops blinking when the focus is locked.)
- ③ **Shooting Icon** (☞ pg. 28)
(Appears and blinks during shooting.)
- ④ **Card Icon** (☞ pg. 28)
☞: Appears during shooting.
☞: Blinks when a memory card is not loaded.
- ⑤ **Picture Quality: FINE and STANDARD (in order of quality)** (☞ pg. 40)
- ⑥ **Remaining Number Of Shot** (☞ pg. 28)
(Displays the approximate remaining number of shots that can be stored during D.S.C. recording, or the remaining number of storable thumbnail images when it reaches 10 or less during video recording. The number increases or decreases depending on the Picture Quality/Image Size, etc.)

During Both Video And D.S.C. Recording

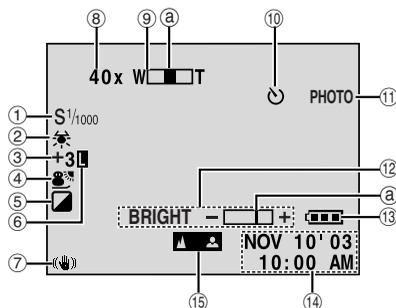

- ① **Shutter Speed/Iris Adjustment Indicator** (☞ pg. 46)
(Appears during manual shutter speed or iris adjustment.)
- ② **White Balance Indicator** (☞ pg. 48)
- ③ **•±: Exposure Adjustment Indicator** (☞ pg. 44)
•☞: Backlight Compensation Indicator (☞ pg. 45)
- ④ **Selected Program AE Indicator** (☞ pg. 50)
- ⑤ **Selected Special Effects Indicator** (☞ pg. 51)
- ⑥ **Iris Lock Indicator** (☞ pg. 45)
- ⑦ **Optical Image Stabilizer ("OIS")** (☞ pg. 37)
- ⑧ **Approximate Zoom Ratio** (☞ pg. 22)
(Appears during zooming.)
- ⑨ **Zoom Indicator** (☞ pg. 22)
(Appears during zooming.)
(The level indicator @ moves.)

- ⑩ **Self-Timer Recording Indicator** (☞ pg. 43)
- ⑪ **PHOTO:** (Appears when taking Snapshot.) (☞ pg. 44)
- ⑫ **BRIGHT: Brightness Control Indicator** (LCD monitor/Viewfinder) (☞ pg. 15)
(The level indicator @ moves.)
- ⑬ **Battery Indicator** (☞ pg. 75)
- ⑭ **Date/Time** (☞ pg. 17)
- ⑮ **Manual Focus Adjustment Indicator** (☞ pg. 47)

During Video Playback

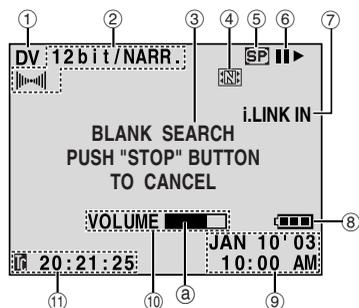

- ① **Video Playback Mode Indicator** (☞ pg. 21)
- ② **Sound Mode Indicator** (☞ pg. 41)
- ③ **Blank Search Indicator** (☞ pg. 25)
- ④ **Thumbnail Storing Indicator** (☞ pg. 53)
(Appears while the captured image is being stored as a thumbnail image in the memory card.)
- ⑤ **Tape Speed** (☞ pg. 36)
- ⑥ **▶▶▶ : Playback**
 - ▶▶▶▶▶ : Fast-Forward/Shuttle Search
 - ◀◀◀◀◀ : Rewind/Shuttle Search
 - || : Pause
 - ||▶▶▶ : Forward Frame-By-Frame Playback/Slow-Motion
 - ◀◀◀|| : Reverse Frame-By-Frame Playback/Slow-Motion
 - ◀▶▶▶ : Audio Dubbing
 - ◀||▶▶▶ : Audio Dubbing Pause
(Appear while a tape is running.)
- ⑦ **Input Mode Indicator** (☞ pg. 54, 56)
- ⑧ **Battery Indicator** (☞ pg. 75)
- ⑨ **Date/Time** (☞ pg. 39, 42)
- ⑩ **VOLUME : Volume Level Indicator** (Speaker or headphone) (☞ pg. 24)
(The level indicator @ moves.)
- **BRIGHT : Brightness Control Indicator** (LCD monitor/Viewfinder) (☞ pg. 15)
(The level indicator @ moves.)
- ⑪ **Time Code** (☞ pg. 39, 42)

During D.S.C. Playback

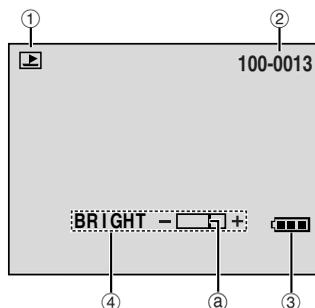

- ① **Operation Mode Indicator** (☞ pg. 30)
- ② **Folder/File Number** (☞ pg. 30)
- ③ **Battery Indicator** (☞ pg. 75)
- ④ **Brightness Control Indicator** (LCD monitor/Viewfinder) (☞ pg. 15)
(The level indicator @ moves.)

A	
AC Power Adapter/Charger	12, 13
Animation	37
Audio Dubbing	60
Auto Focus	46
Auto Playback Of Images	29
Auto Shut Off	20, 28
B	
Backlight Compensation	45
Battery Pack	12, 13, 78
Beep (BEEP)	38
Blank search	25
Brightness Adjustment Of The Display (BRIGHT)	15
Built-in Clock's Rechargeable Lithium Battery	17
C	
Changing The Menu Settings	35
Channels (Left/Right)	41
Charging The Battery Pack	12
Cleaning The Camcorder	81
Clock adjustment (CLOCK ADJ.)	17
Component video output setting (Y/Pb/Pr)	26
Connections	
Charging	12
Dubbing	54 – 57
Random Assemble Editing	62 – 66
To A PC	67
To A TV Or VCR	26
WebCam	68
D	
Date/Time	
Display (DATE/TIME)	39, 42
Settings	17
DCF (Design rule for Camera File system)	28, 29
Deleting Files (DELETE)	32
Deleting thumbnail images (NAVI.DEL.)	41
Display	42
DPOF Setting (Digital Print Order Format)	33, 34
Dubbing	54 – 57
Dubbing from tape to memory card (   COPY)	41, 57
E	
Erase Protection	18, 19
Exposure Control (EXPOSURE)	44
F	
Fade-In/Out	50
Fast-Forward The Tape	24
Frame-By-Frame Playback	59
G	
Gain Up (GAIN UP)	36
Grip Adjustment	14
I	
i.LINK output setting (i.LINK OUT)	39
Image Size (IMAGE SIZE)	40
Index Playback Of Files	30
Indications on the LCD Monitor/Viewfinder ..	86, 87
Initialising A Memory Card (FORMAT)	34
Insert Editing	61
Interface Shooting	22
Iris	45
Iris Lock	45
J	
Journalistic Shooting	22
L	
Loading A Cassette	18
Loading A Memory Card	19
M	
Manual Focus	47
Manual Iris	46
Manual Shutter Speed	46
Manual Zooming	47
Memory Card	19, 79
Menu Screen	
CAMERA	36
CAMERA DISPLAY	39
D.S.C. Playback	30 – 34
DSC	40
MANUAL	37
SYSTEM	38, 42
VIDEO	41
VIDEO DISPLAY	42
Motor Drive Mode	44
MultiMediaCard	19, 79
N	
Navigation (NAVIGATION)	36, 52, 53
O	
Optical Image Stabilization (OIS)	37

P	
Picture Quality (QUALITY)	40
Playback Mode Switch Position	16
Playback sound (SOUND MODE, NARRATION)	41
Playback Special Effects	60
Playback Zoom	59
Power Switch Position	16
Priority Setting (PRIORITY)	38
Program AE (PROGRAM AE)	
Snow (SNOW)	50
Sports (SPORTS)	50
Spotlight (SPOTLIGHT)	50
Twilight (TWILIGHT)	51
Protecting Files (PROTECT)	31
Provided Accessories	7
R	
Random Assemble Editing	62 – 66
Recording media selection (REC SELECT)	40
Recording Mode (REC MODE)	36, 41
Recording Mode Switch Position	16, 21
Recording Time	
Tape	18
Record-Standby	20
Remaining Power Level	75
Remote Control	58
Remote control setting (REMOTE)	38
Resetting Menu Settings (CAM RESET)	39
Resetting The File Name	33
Rewind The Tape	24
S	
SD Memory Card	19, 79
Self-Timer (SELF-TIMER)	37, 43
Set Remote/VCR Code	62
Shuttle Search	25
Slow-Motion Playback	59
Snapshot	28, 44
Sound Mode (DV SOUND)	36
Sound Mode (SOUND MODE)	41
Speaker Volume	24
Special Effects (EFFECT)	
Classic Film (CLASSIC FILM)	51
Monotone (MONOTONE)	51
Sepia (SEPIA)	51
Strobe (STROBE)	51
Specifications	82, 83
Still Playback	24
S-Video output setting (S/VIDEO)	39
S-Video/AV input (S/AV INPUT)	41, 54
Synchro adjustment (SYNCHRO)	66
T	
Tally Lamp (TALLY)	20, 38
Telephoto setting (TELE MACRO)	37
Time Code (TIME CODE)	23, 39, 42
Tripod Mounting	14
U	
Unloading A Cassette	18
Unloading A Memory Card	19
V	
Viewfinder Adjustment	15
W	
WebCam	68
White Balance (W.BALANCE)	48
Wide Mode (DV WIDE)	
Squeeze (SQUEEZE)	38
Wide (D.WIDE)	38
Wipe In/Out	50
Z	
Zooming (ZOOM)	22, 36
5-Second Recording (5S)	37

